

**1631**

**Size XXSm to XXLg**

Includes pattern & instructions



**FUNtastic Patterns for Little Dogs!**



**Step In Harness A**



**Step In Harness B**



© 2018 Sofi & Friends \* Sold for personal use only and not for commercial or manufacturing purposes

**To print patterns properly select the following options in Adobe Reader print section:  
Size Options - "Actual Size"  
Orientation - "Auto portrait/landscape"**

**Pattern 1631**  
**Size XXSm to XXLg**



Step In  
 Harness A



Step In  
 Harness B

**SUGGESTED FABRICS:** light to medium weight cotton & cotton blends

**NOTIONS**

**Harness A:** lace trim - 3/8 yd XXSm & XSm; 1/2 yd Sm & Med; 5/8 yd Lg & XLg; 2/3 yd XXLg

**BOTH Harnesses:** thread; Velcro - 1" XXSm & XSm; 1 1/2" Sm & Med & Lg & XLg; 2" XXLg  
 fusible interfacing - sheerweight XXSm to XLg; featherweight XXLg

D-Ring - 3/8" XXSm; 1/2" XSm to Lg; 3/4" XLg to XXLg

Bias Tape - 2 yd XXSm; 2 1/2 yd XSm & Sm & Med; 2 3/4 yd Lg; 3 1/4 yd XLg; 3 1/2 yd XXLg

**BODY MEASUREMENTS** - See measurement image on next page

	<b>XXS</b>	<b>XS</b>	<b>SM</b>	<b>MED</b>	<b>LG</b>	<b>XLG</b>	<b>XXLG</b>
Neck	5 1/2 - 7"	6 1/2 - 8"	7 - 8 1/2"	7 3/4 - 9 1/4"	9 - 10 1/2"	10 - 11 1/2"	12 - 13 1/2"
Girth	9 1/4 - 10 3/4"	10 1/2 - 12"	12 - 13 1/2"	13 1/4 - 14 3/4"	15 - 16 3/4"	16 1/2 - 18 1/2"	19 - 21"
Length	7 3/8"+	8 1/8"+	8 7/8"+	10"+	10 5/8"+	12"+	13 3/4"+

**Measuring your Dog** - use a soft tape measure keeping it a bit loose; you should be able to slide a finger between the dog and tape

**NECK:** Measure around widest part of neck where collar sits

**GIRTH:** Measure behind front legs where chest starts

**LENGTH:** Measure from base of neck (between shoulder blades) to where tail starts

**STEP IN HARNESS A**

<b>Fabric A</b>	1/4	1/3	1/3	1/3	3/8	1/2	1/2
45" (yd)							
<b>Fabric B</b>	1/4	1/3	1/3	1/3	3/8	1/2	1/2
45" (yd) Extra for DIY bias tape							
<b>Fabric C</b>	1/8	1/8	1/4	1/4	1/3	1/3	1/3
45" (yd)							
<b>Interfacing</b>	1/4	1/3	1/3	1/3	3/8	2/3	2/3
20" (yd)							

**STEP IN HARNESS B**

<b>Fabric A</b>	1/4	1/3	1/3	1/3	3/8	1/2	1/2
45" (yd)							
<b>Fabric B</b>	1/4	1/3	1/3	1/3	3/8	1/2	1/2
45" (yd) Extra for DIY bias tape							
<b>Fabric C</b>	1/8	1/8	1/8	1/4	1/3	1/3	1/3
45" (yd)							
<b>Interfacing</b>	1/4	1/3	1/3	1/3	3/8	2/3	2/3
20" (yd)							

Use 1/4" (XXSm to Lg) or 3/8" (XLg to XXLg) seam allowance on all seams unless otherwise noted. Press all seam allowances as noted in instructions.

### Optional D-Ring for your leash

You may add a D-Ring to use with your own leash. The D-Ring on this garment is meant for "gentle tuggers" only. Please take necessary precautions.

### Pattern Markings

←→ Grainline - Place on straight grain of fabric, parallel to selvage or fold.

FOLD Place line on fold of fabric.

### GLOSSARY

EASESTITCH-Stitch along seamline, using long machine stitches. Pull thread ends to adjust the fit.

GATHER-Stitch along seamline using long machine stitches. Pull thread ends to adjust the fit.

REINFORCE-Stitch again along seamline using small machine stitches.

TOPSTITCH-On outside, stitch 1/8" to 3/16" from seam depending on size of pattern.

CLIP CURVES-Notch inside curves and clip outside curves.

TRIM CORNERS-Trim excess fabric from outside corners.

FINISH EDGE-Use a zigzag stitch, or stitch of your choice, to finish raw edge of fabric.

### TIPS

Use knitting needle to **gently** turn square corners right side out.

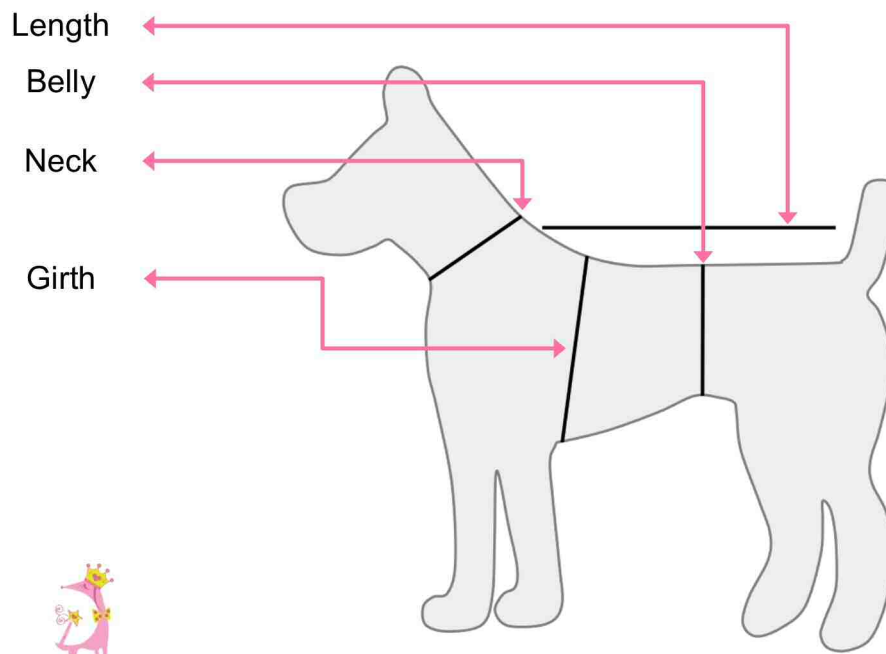

The following instructions demonstrate how to alter this pattern to fit your dog perfectly. Begin with the Body Measurements noted on the 1st page of the pattern. When selecting a size choose one that will give your dog the best overall fit. Girth is most important, then Neck and then Length.

**Altering Girth**

- 1) The quickest method involves adding to the Velcro length which makes a smaller girth. The pattern indicates width and length of Velcro. See View A below.
- 2) View B shows the second method which involves altering the pattern as follows. Patterns are made to fit comfortably the largest number on the size range. For example, the girth range on a size Large pattern is 15" to 16 3/4". The pattern is designed to fit perfectly on a dog with a 16 3/4" girth. If your dog's girth size is 15 3/4", subtract 15 3/4" from 16 3/4" equaling 1". The overall girth measurement needs to be 1" less so the belly strap would be trimmed 1/2".

View A

Adding length to Velcro causes more belly strap overlap making the girth smaller. If working with this method the D-Ring placement will change otherwise they will not line up properly as shown.

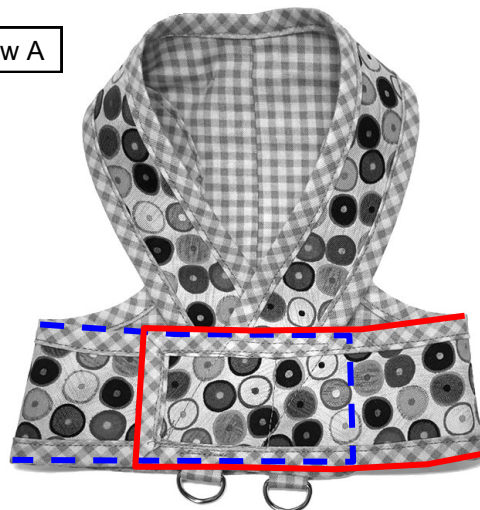

View B

Add to or trim from RED lines altering harness & lining by equal amounts

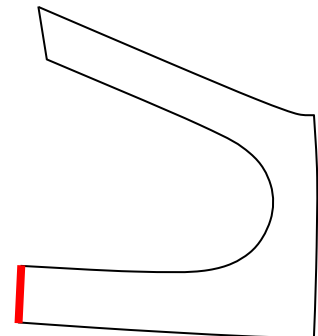

**Altering Length**

To shorten/lengthen harness add to or trim from RED lines. Alter harness & lining by equal amounts.

Note: belly straps should fit between chest and mid belly area.

When altering length the neck straps need altering as well. If harness is lengthened 1" the neck strap needs an additional 1".

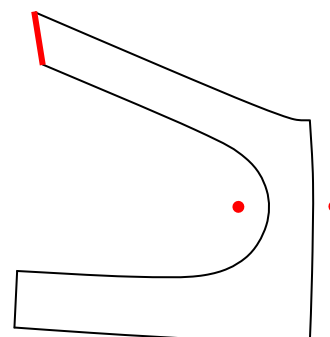

**SEWING INSTRUCTIONS**

- 1) Following manufacturer's instructions apply interfacing to both Harness Body pieces.
- 2) RIGHT sides together sew Harness Body seam. (View A)
- 3) Press seam open.

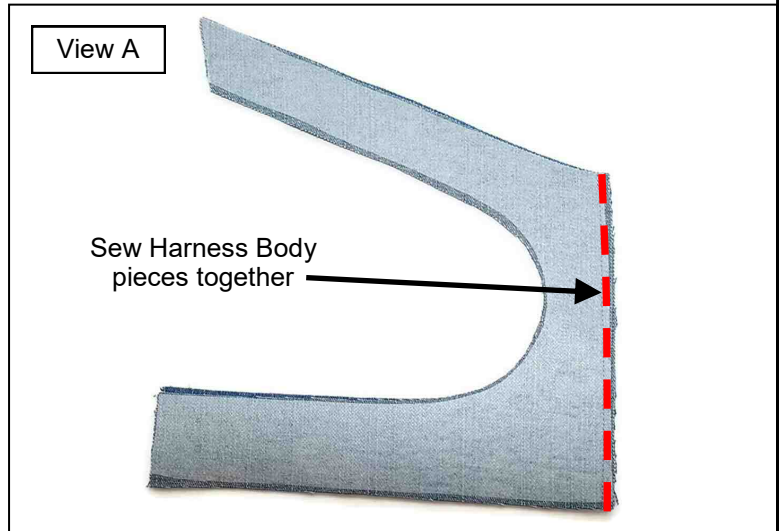

- 4) RIGHT sides together sew Lining seam. (View B)
- 5) Press seam open.

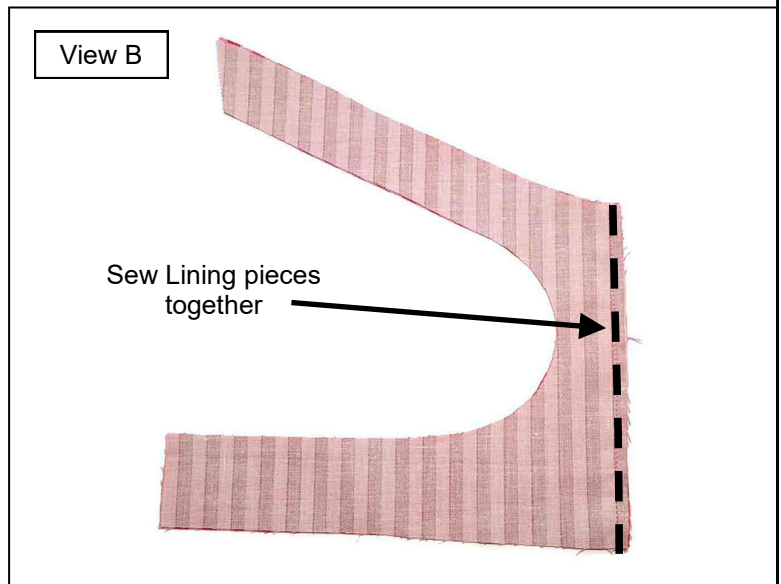

- 6) WRONG sides together baste Lining to Harness Body sewing close to edges. (View C)

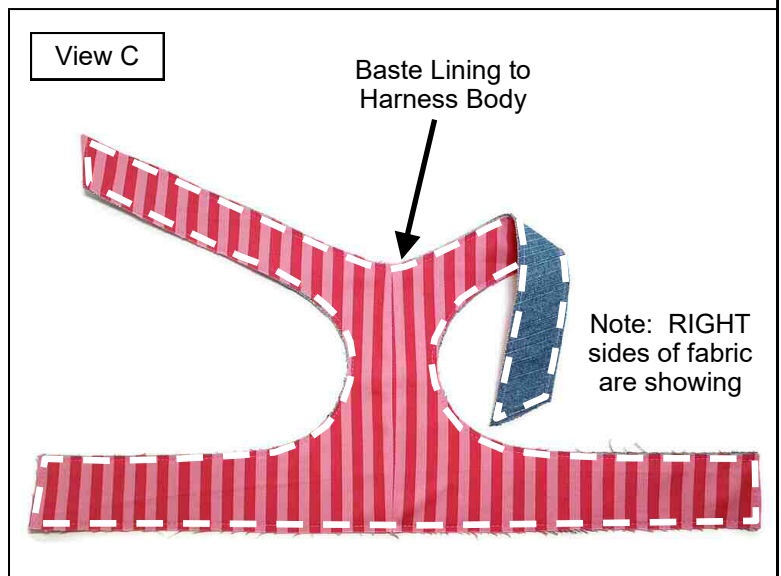

7) Finish one long edge of Ruffle with a zigzag or stitch of choice to prepare for hem. (View D)



8) Fold, press & sew hem in place on long finished edge. (View E)

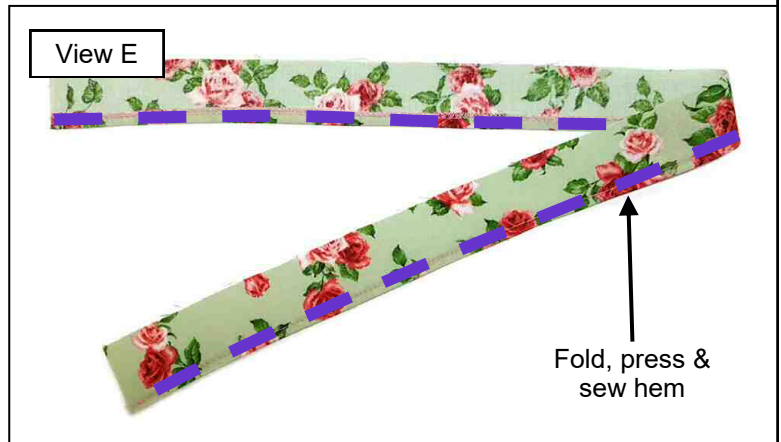

9) Gather remaining long unfinished Ruffle edge. (View F)



10) Sew gathered Ruffle to harness neck between symbols sewing close to edge. (View G)

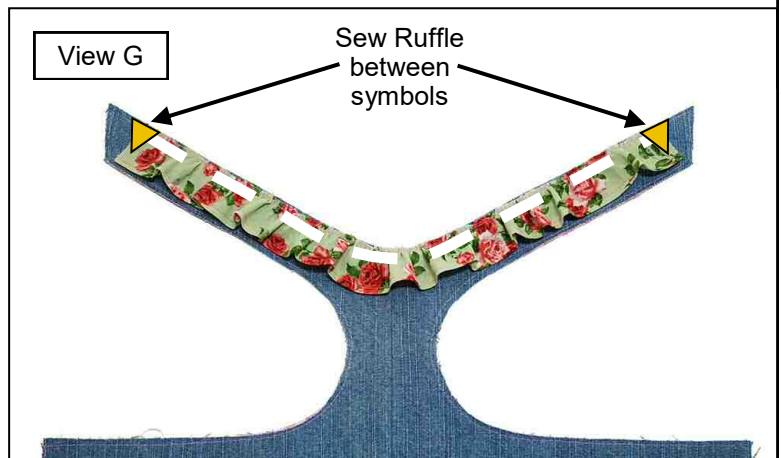

11) Optional: sew lace to Ruffle. (View H)

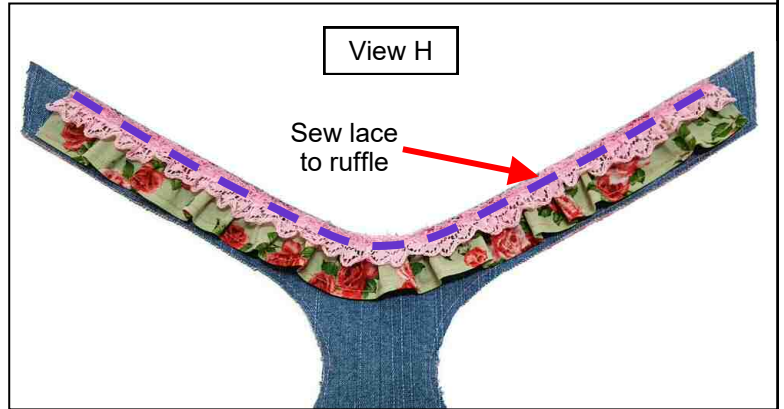

12) Sew bias tape to neck edge. (View I)

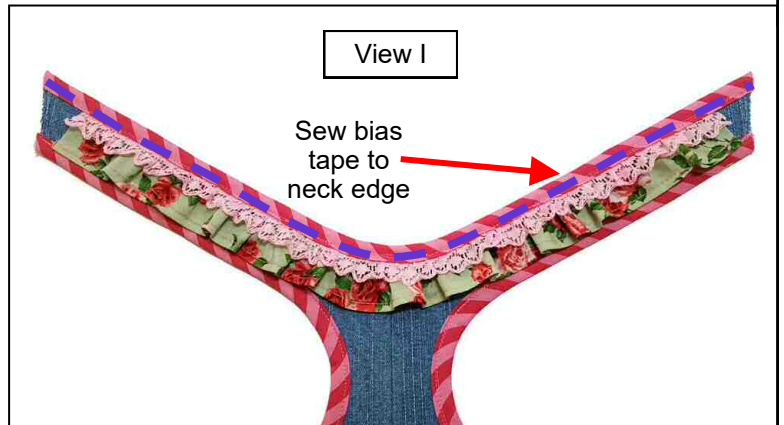

13) Sew bias tape to remaining harness edges. (View J)

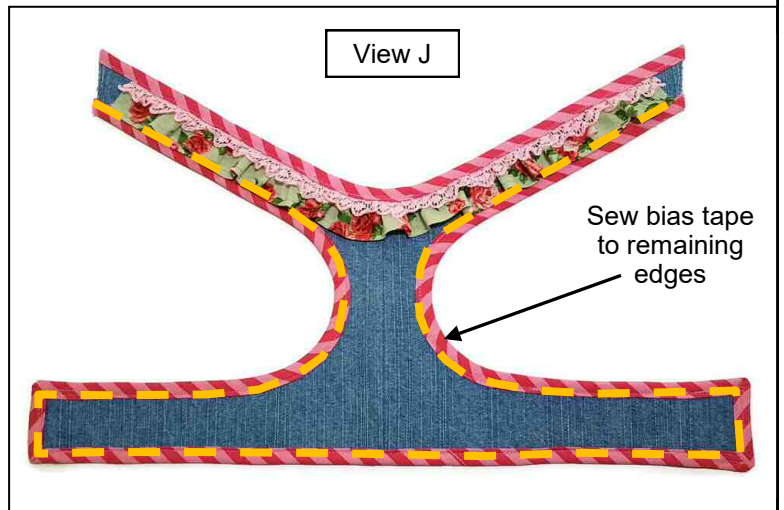

14) Finish raw ends of neck straps with a zigzag or stitch of choice. (View K)



15) Following manufacturer's instructions apply interfacing to D-Ring Loops.

16) Fold, press & sew loops following pattern fold lines. (View L)

17) Slide loops through D-Rings. Fold loops in half & sew close to D-Rings. (View L)



View M

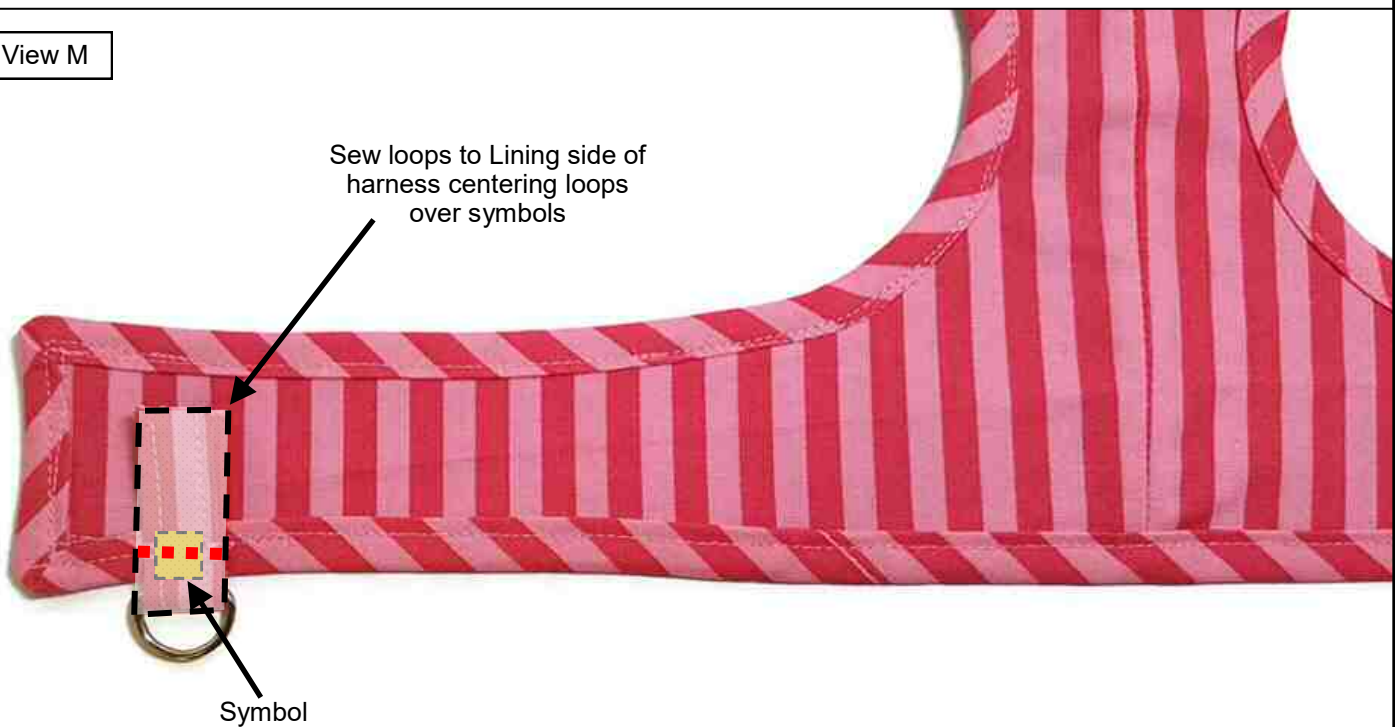

18) Sew loops to Lining side of harness centering each over square symbols. (View M)  
Note: D-Ring placement may vary if girth is altered. See alterations page 3.

19) View N shows both D-Rings sewn to Lining side of harness. (View N)





20) Sew RIGHT side of shoulder straps to LINING side of belly straps. D-Ring Loops are sandwiched between the two. (View O)  
Note: shoulder strap offsets edge of belly strap.

21) View P below shows both shoulder straps sewn in place. (View P)

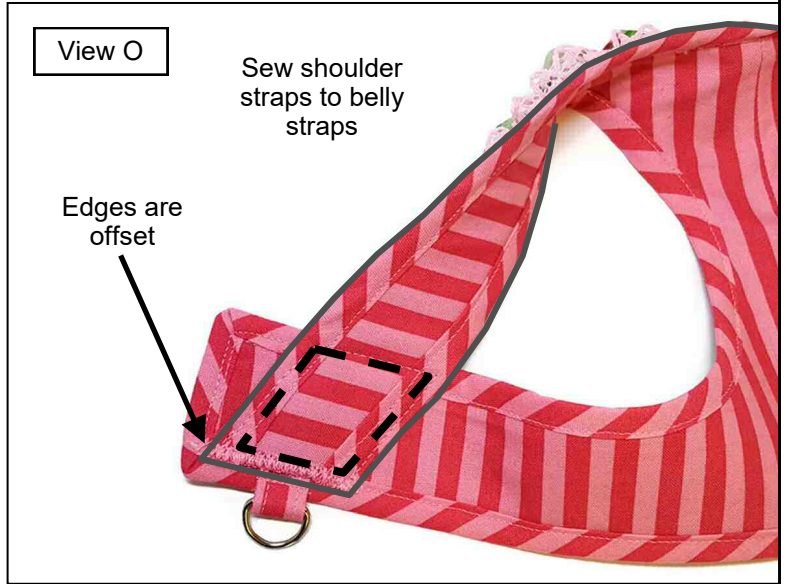

View P

Shoulder straps sewn in place



22) Attach Velcro to harness belly straps. (View Q)

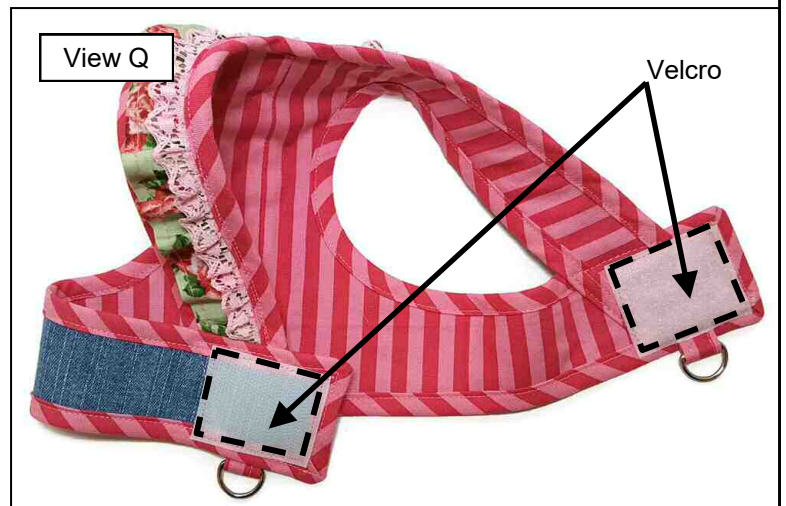

23)RIGHT sides together sew seams on all four sides of Girls Bow. (View R)

24)Trim corners. (View R)

View S



View R

Sew seams on bow



25)Pucker bow and cut slit on one side of bow per pattern instructions. (View S)

26)Turn bow right side out through slit and press. (View T)

View T

Turn bow right side out & press



27)Finish raw edges of slit with Fray Check and let dry.

28)Fold & press Bow Knot edges following pattern fold lines. (View U)

29)Fold Bow Knot in half and sew edges. (View U)

View U

Fold & press Bow Knot on fold lines



Fold in half & sew edges



30) Pinch & fold center of bow. (View V)



31) Wrap Bow Knot around center of bow. Knot is glued or sewn to bow. Trim extra length. (View W)



32) Attach bow to harness with a sew on snap. (View X)



**SEWING INSTRUCTIONS**

- 1) Follow instructions for Harness A steps 1 through 6. Skip steps 7 through 11.
- 2) Follow instructions for Harness A steps 12 through 22.
- 3) Follow instructions for Harness A steps 23 through 31 using boys bow instead of girls bow.
- 4) Attach bow to center of chest panel with sew on snap. (View B)

View A



View B



### PATTERN PIECES

- 1) HARNESS A&B BODY
- 2) HARNESS A RUFFLE
- 3) HARNESS A&B D-RING
- 4) HARNESS A&B BOW KNOT
- 5) HARNESS A GIRLS BOW
- 6) HARNESS B BOYS BOW
- 7) DIY BIAS TAPE GUIDE

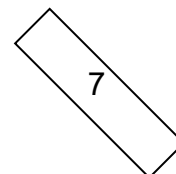
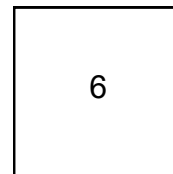
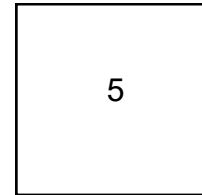
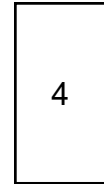
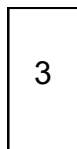
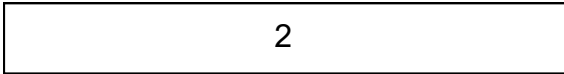
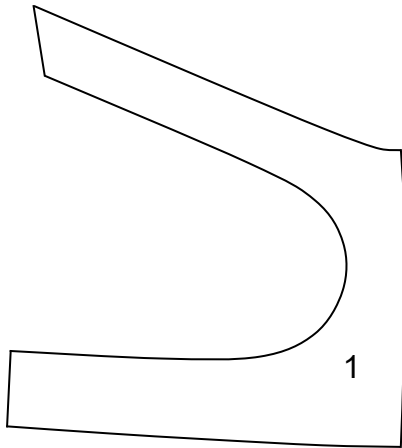

**HARNESS A**

**STEP IN HARNESS A Fabric A**

USE PIECE 1

45" fabric

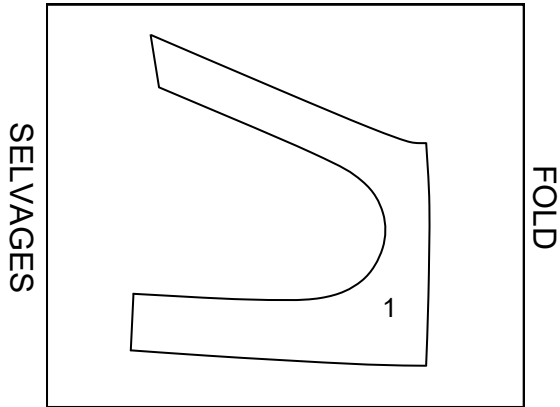

**STEP IN HARNESS A Interfacing**

USE PIECES 1 3

20" interfacing **Cut one of 3**

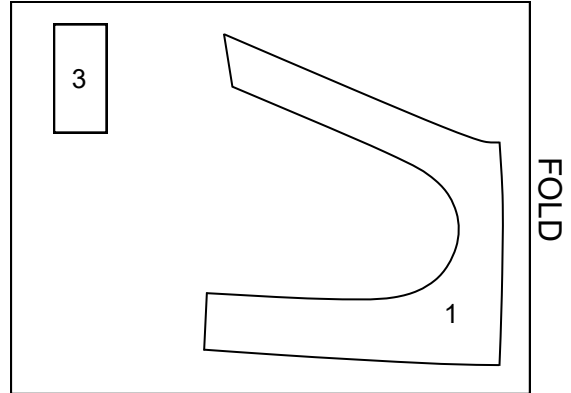

**STEP IN HARNESS A Fabric C**

USE PIECES 2 4 5

45" fabric

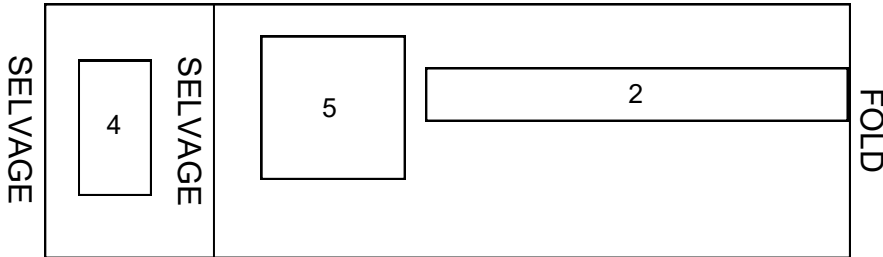

**STEP IN HARNESS A Fabric B**

USE PIECES 1 3

45" fabric **Cut one of 3**

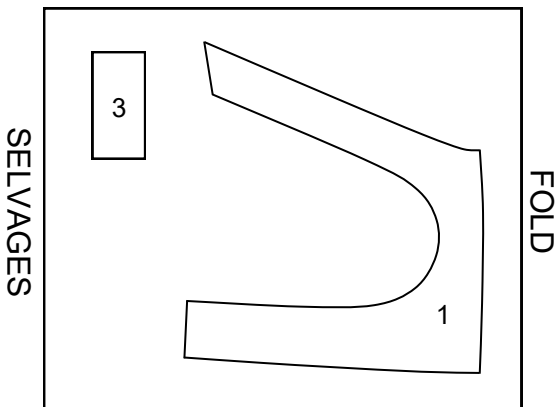

#7 DIY Bias Tape - Fabric B

1631 **XXSMALL**  
 STEP IN HARNESS A&B  
 DIY DOUBLE FOLD BIAS TAPE  
 Cut 1" strips to make  
 1/2" tape that folds to 1/4"  
 Need 2 Yards

1631 **XSMALL**  
 STEP IN HARNESS A&B  
 DIY DOUBLE FOLD BIAS TAPE  
 Cut 1 1/2" strips to make  
 3/4" tape that folds to 3/8"  
 Need 2 1/2 Yards

**HARNESS B**

**STEP IN HARNESS B Fabric A**

USE PIECE 1

45" fabric

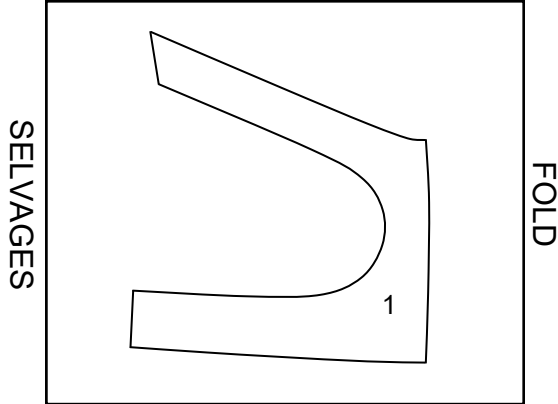

**STEP IN HARNESS B Fabric C**

USE PIECES 4 6

45" fabric

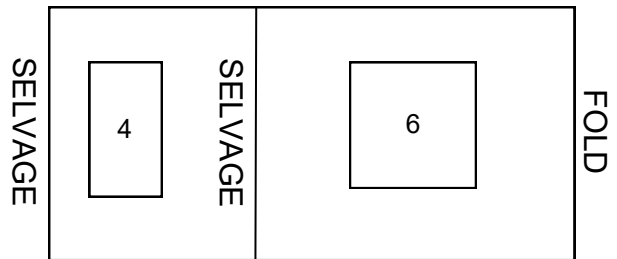

**STEP IN HARNESS B Fabric B**

USE PIECES 1 3

45" fabric **Cut one of 3**

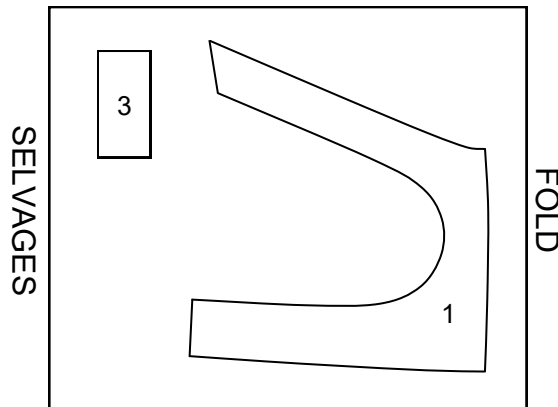

**STEP IN HARNESS B Interfacing**

USE PIECES 1 3

20" interfacing **Cut one of 3**

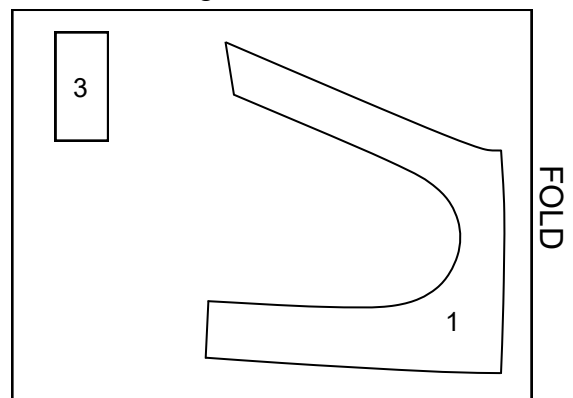

#7 DIY Bias Tape - Fabric B

1631 **XXSMALL**  
 STEP IN HARNESS A&B  
 DIY DOUBLE FOLD BIAS TAPE  
 Cut 1" strips to make  
 1/2" tape that folds to 1/4"  
 Need 2 Yards

1631 **XSMALL**  
 STEP IN HARNESS A&B  
 DIY DOUBLE FOLD BIAS TAPE  
 Cut 1 1/2" strips to make  
 3/4" tape that folds to 3/8"  
 Need 2 1/2 Yards

### PATTERN PIECES

- 1) HARNESS A&B BODY Section 1
- 2) HARNESS A&B BODY Section 2
- 3) HARNESS A RUFFLE Section 1
- 4) HARNESS A RUFFLE Section 2
- 5) HARNESS A&B D-RING
- 6) HARNESS A&B BOW KNOT
- 7) HARNESS A GIRLS BOW
- 8) HARNESS B BOYS BOW
- 9) DIY BIAS TAPE GUIDE

Tape pattern pieces together prior to cutting fabric.

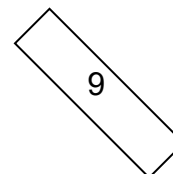
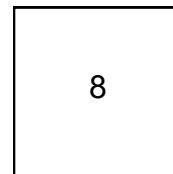
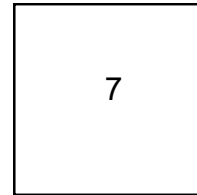
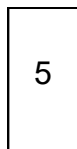
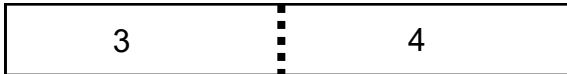
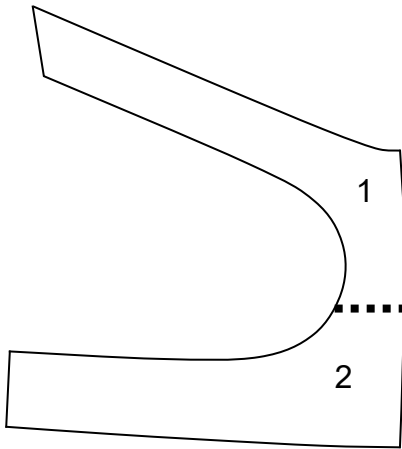



**HARNESS A**

**STEP IN HARNESS A Fabric A**

USE PIECES 1/2  
45" fabric

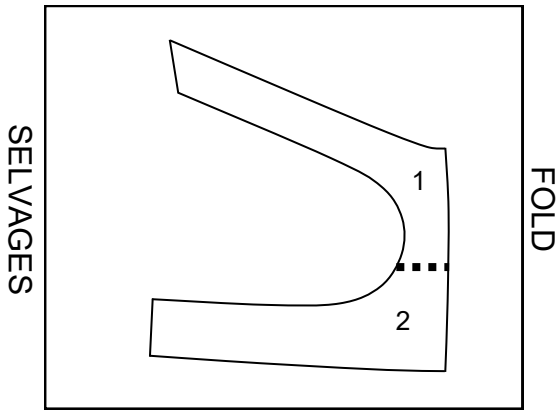

**STEP IN HARNESS A Fabric C**

USE PIECES 3/4 6 7  
45" fabric

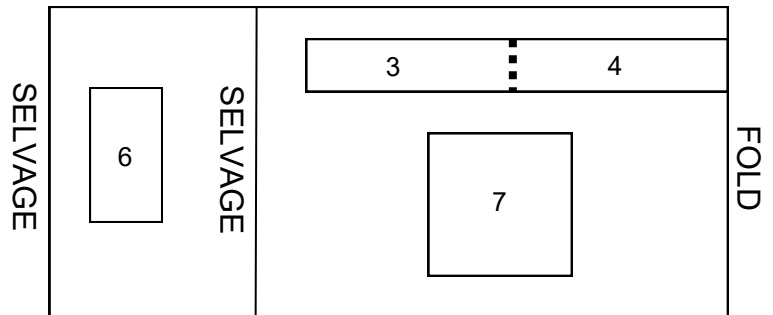

**STEP IN HARNESS A Fabric B**

USE PIECES 1/2 5  
45" fabric **Cut one of 5**

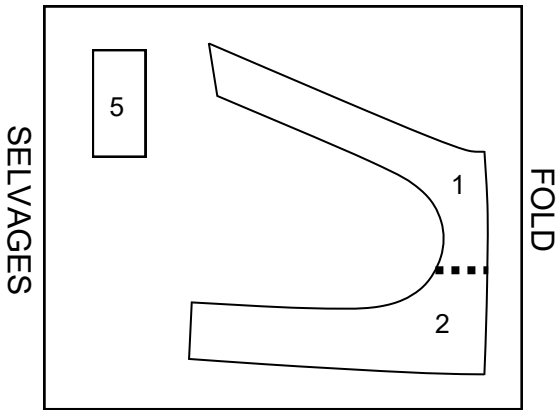

**STEP IN HARNESS A Interfacing**

USE PIECES 1/2 5  
20" interfacing **Cut one of 5**

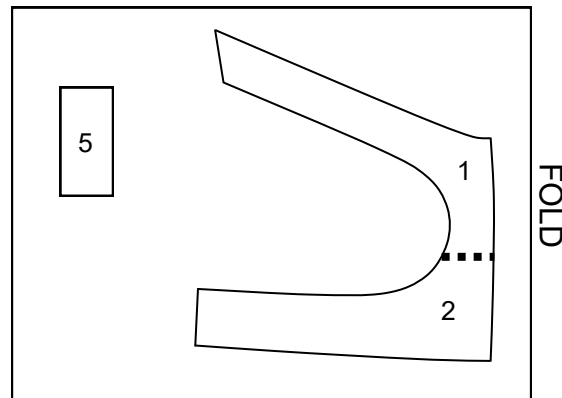

#9 DIY Bias Tape - Fabric B

**1631 SMALL**  
**STEP IN HARNESS A&B**  
**DIY DOUBLE FOLD BIAS TAPE**  
Cut 1 1/2" strips to make  
3/4" tape that folds to 3/8"  
Need 2 1/2 Yards

**1631 MEDIUM**  
**STEP IN HARNESS A&B**  
**DIY DOUBLE FOLD BIAS TAPE**  
Cut 1 1/2" strips to make  
3/4" tape that folds to 3/8"  
Need 2 1/2 Yards

**HARNESS B**

**STEP IN HARNESS B Fabric A**

USE PIECES 1/2  
45" fabric

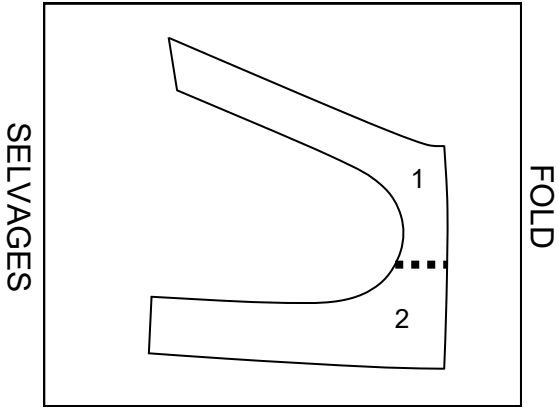

**STEP IN HARNESS B Fabric C**

USE PIECES 6 8  
45" fabric

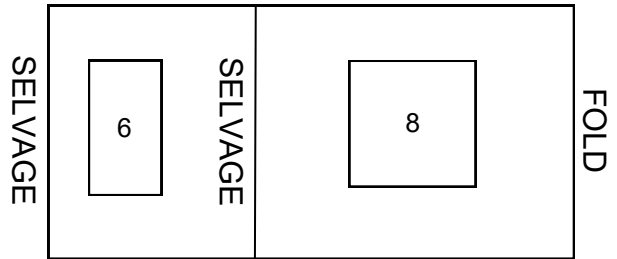

**STEP IN HARNESS B Fabric B**

USE PIECES 1/2 5  
45" fabric **Cut one of 5**

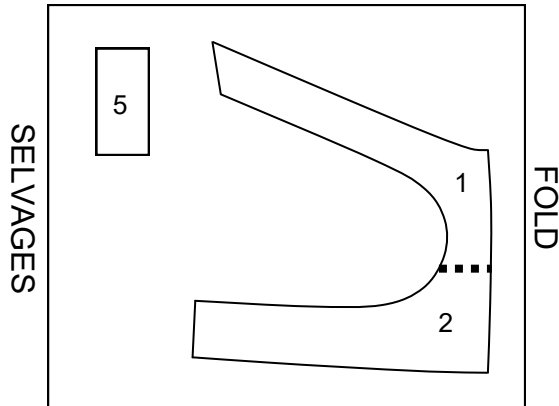

**STEP IN HARNESS B Interfacing**

USE PIECES 1/2 5  
20" interfacing **Cut one of 5**

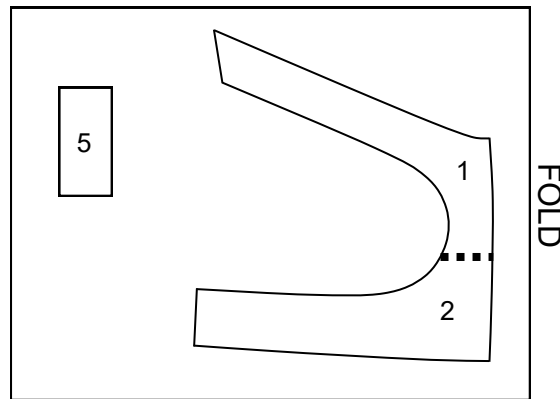

#9 DIY Bias Tape - Fabric B

1631 **SMALL**  
STEP IN HARNESS A&B  
DIY DOUBLE FOLD BIAS TAPE  
Cut 1 1/2" strips to make  
3/4" tape that folds to 3/8"  
Need 2 1/2 Yards

1631 **MEDIUM**  
STEP IN HARNESS A&B  
DIY DOUBLE FOLD BIAS TAPE  
Cut 1 1/2" strips to make  
3/4" tape that folds to 3/8"  
Need 2 1/2 Yards

### PATTERN PIECES

- 1) HARNESS A&B BODY Section 1
- 2) HARNESS A&B BODY Section 2
- 3) HARNESS A&B BODY Section 3
- 4) HARNESS A RUFFLE Section 1
- 5) HARNESS A RUFFLE Section 2
- 6) HARNESS A&B D-RING
- 7) HARNESS A&B BOW KNOT
- 8) HARNESS A GIRLS BOW
- 9) HARNESS B BOYS BOW
- 10)DIY BIAS TAPE GUIDE

Tape pattern pieces together prior to cutting fabric.

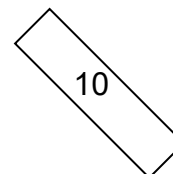
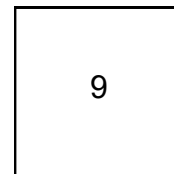
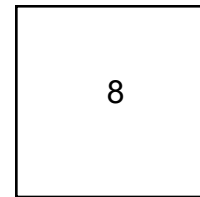
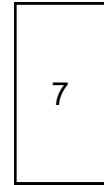
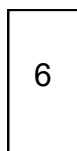
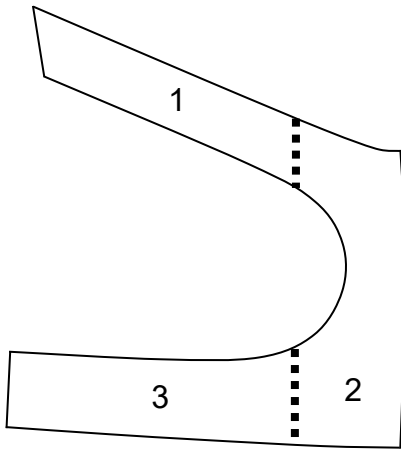

**HARNES A**

**STEP IN HARNES A Fabric A**

USE PIECES 1/2/3

45" fabric

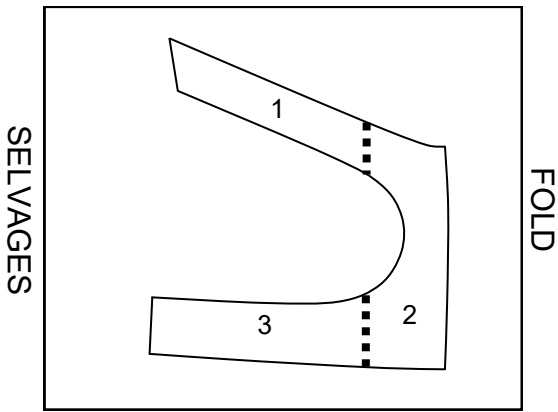

**STEP IN HARNES A Fabric C**

USE PIECES 4/5 7 8

45" fabric

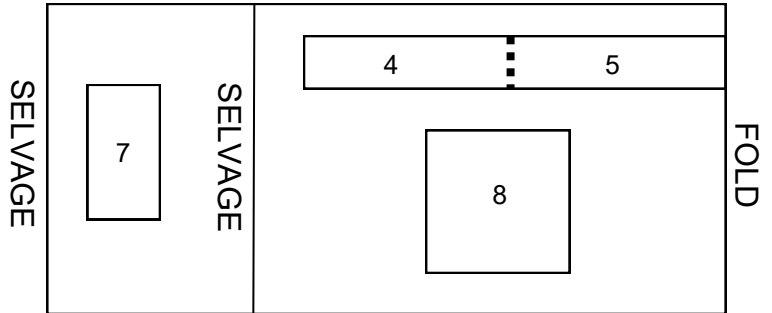

**STEP IN HARNES A Fabric B**

USE PIECES 1/2/3 6

45" fabric **Cut one of 6**

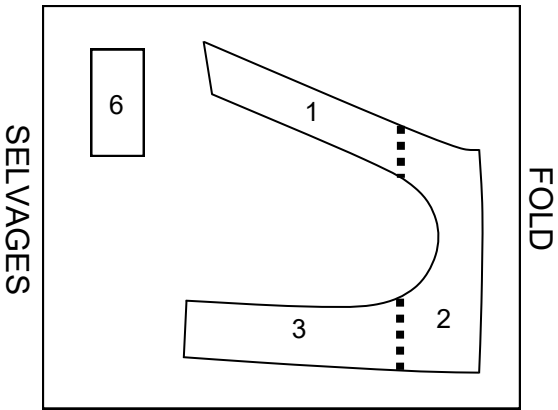

**STEP IN HARNES A Interfacing**

USE PIECES 1/2/3 6

20" interfacing

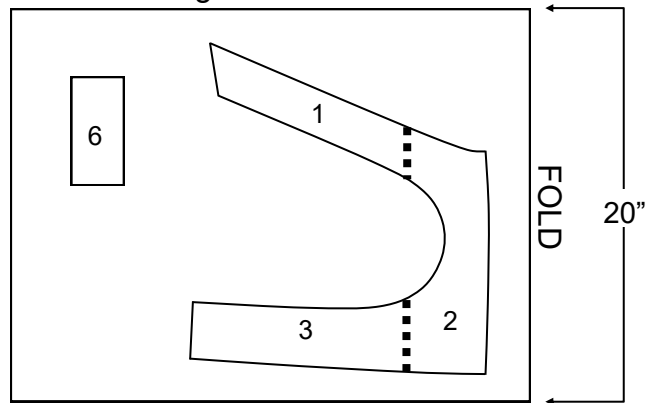

#10 DIY Bias Tape - Fabric B

**1631 LARGE**  
**STEP IN HARNES A&B**  
**DIY DOUBLE FOLD BIAS TAPE**  
 Cut 1 1/2" strips to make  
 3/4" tape that folds to 3/8"  
 Need 2 3/4 Yards

**1631 XLARGE**  
**STEP IN HARNES A&B**  
**DIY DOUBLE FOLD BIAS TAPE**  
 Cut 2" strips to make  
 1" tape that folds to 1/2"  
 Need 3 1/4 Yards

**1631 XXLARGE**  
**STEP IN HARNES A&B**  
**DIY DOUBLE FOLD BIAS TAPE**  
 Cut 2" strips to make  
 1" tape that folds to 1/2"  
 Need 3 1/2 Yards

**HARNES B**

**STEP IN HARNES B Fabric A**

USE PIECES 1/2/3  
45" fabric

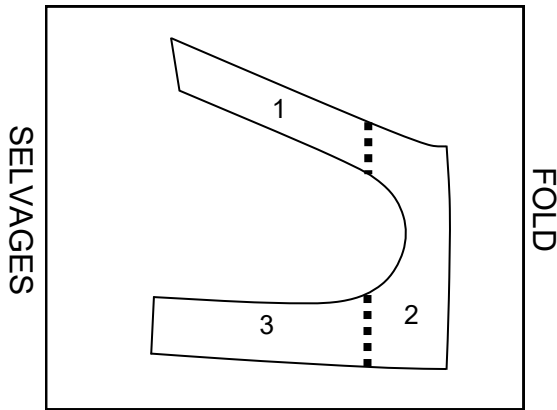

**STEP IN HARNES A Fabric B**

USE PIECES 1/2/3 6  
45" fabric **Cut one of 6**

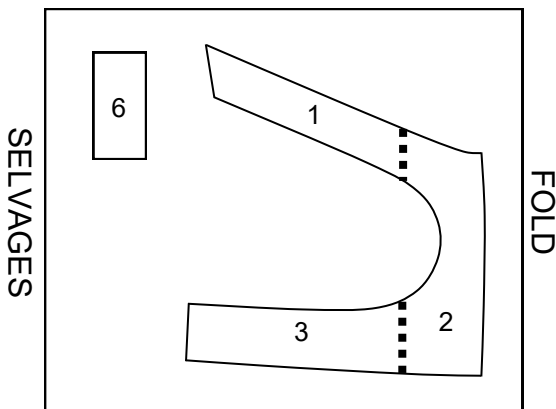

**STEP IN HARNES B Fabric C**

USE PIECES 7 9  
45" fabric

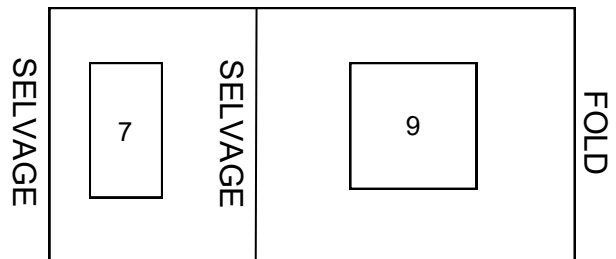

#10 DIY Bias Tape - Fabric B

**1631 LARGE**  
**STEP IN HARNES A&B**  
**DIY DOUBLE FOLD BIAS TAPE**  
Cut 1 1/2" strips to make  
3/4" tape that folds to 3/8"  
Need 2 3/4 Yards

**1631 XLARGE**  
**STEP IN HARNES A&B**  
**DIY DOUBLE FOLD BIAS TAPE**  
Cut 2" strips to make  
1" tape that folds to 1/2"  
Need 3 1/4 Yards

**1631 XXLARGE**  
**STEP IN HARNES A&B**  
**DIY DOUBLE FOLD BIAS TAPE**  
Cut 2" strips to make  
1" tape that folds to 1/2"  
Need 3 1/2 Yards

**STEP IN HARNES A Interfacing**

USE PIECES 1/2/3 6  
20" interfacing

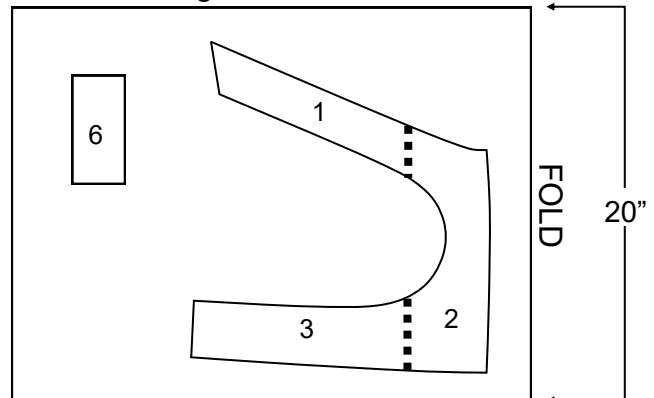

1631 XXSMALL

7  STEP IN HARNESS A&B  
DIY DOUBLE FOLD BIAS TAPE

FABRIC B

1/2" Tape folds to 1/4"

Cut 2 Yards

SOFI & FRIENDS

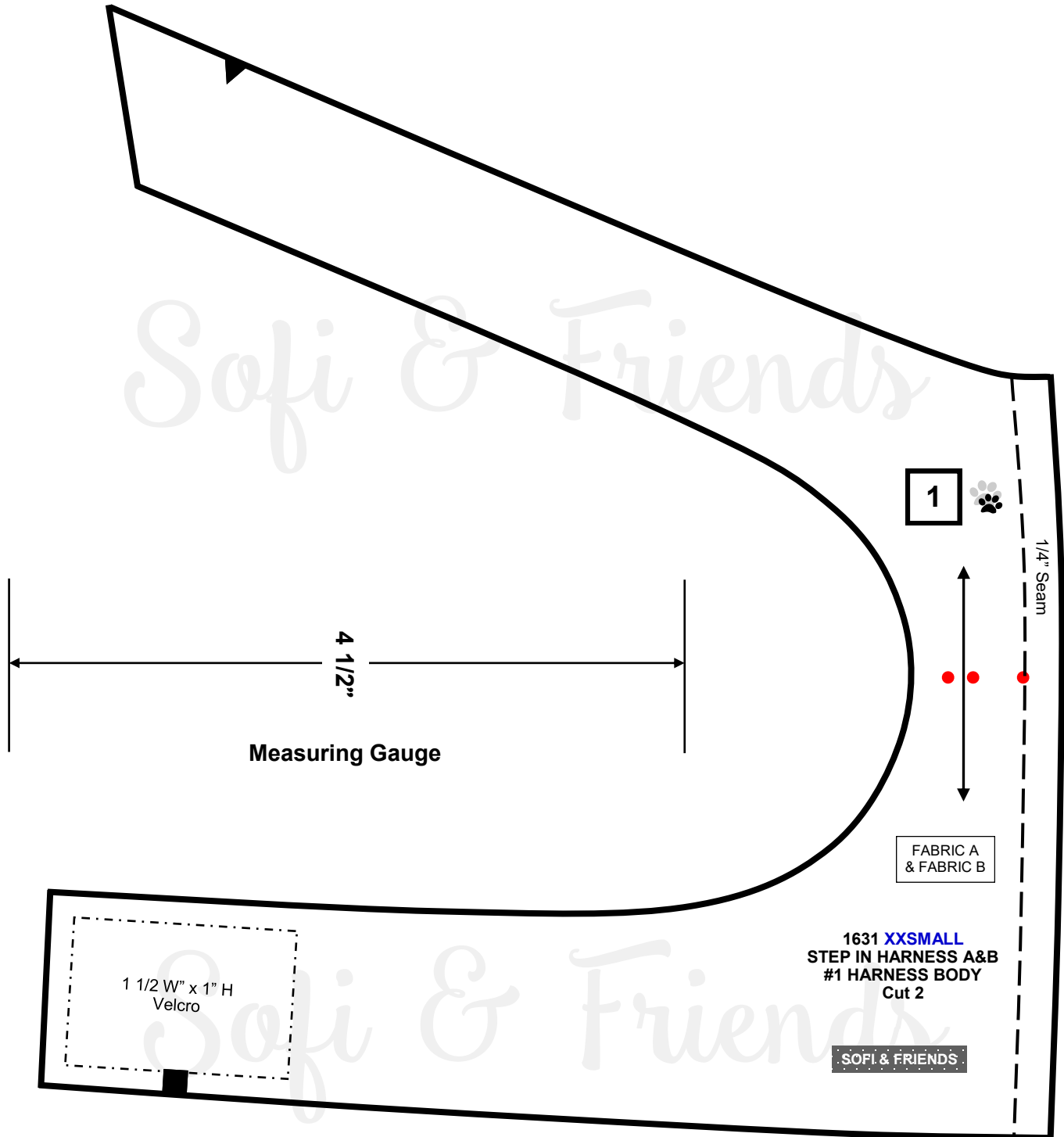
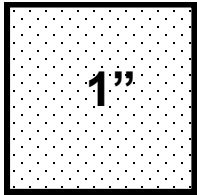

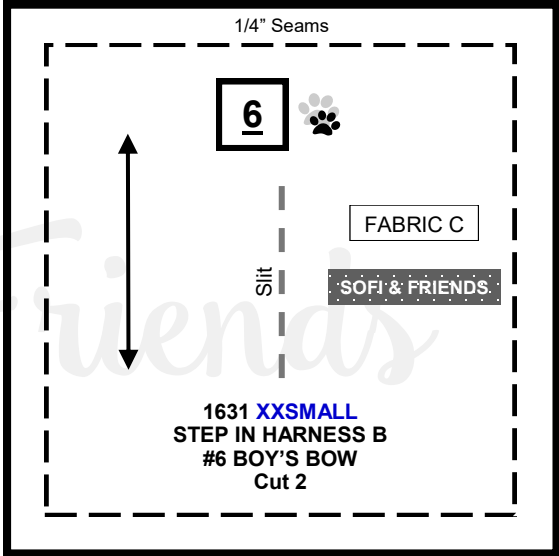
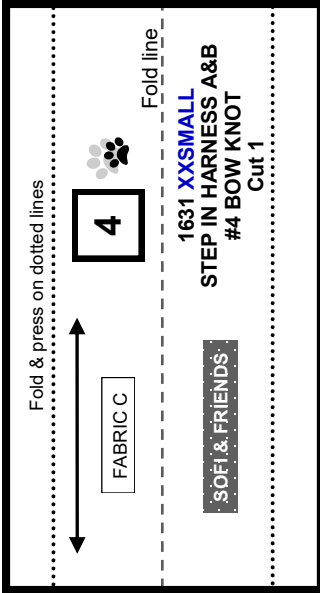
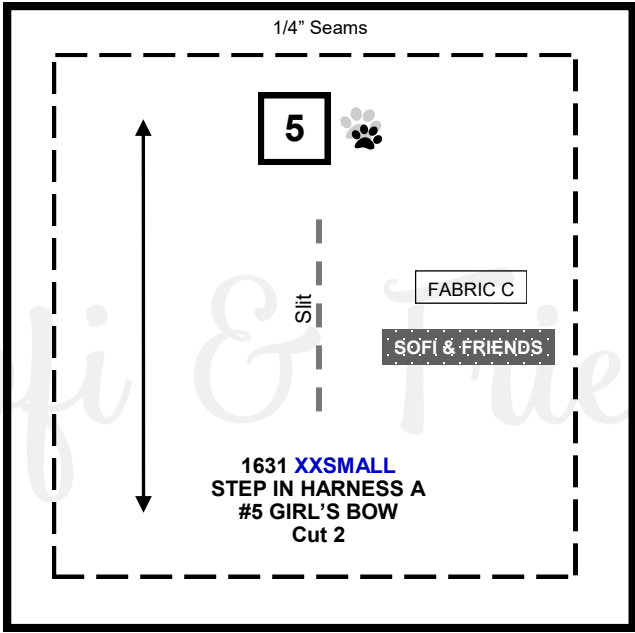
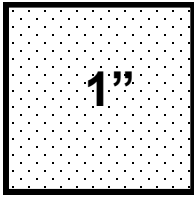
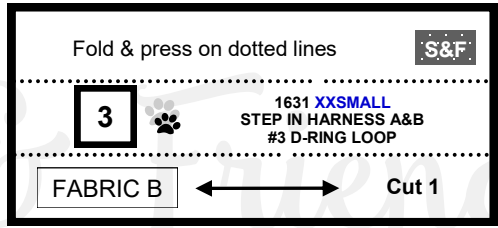
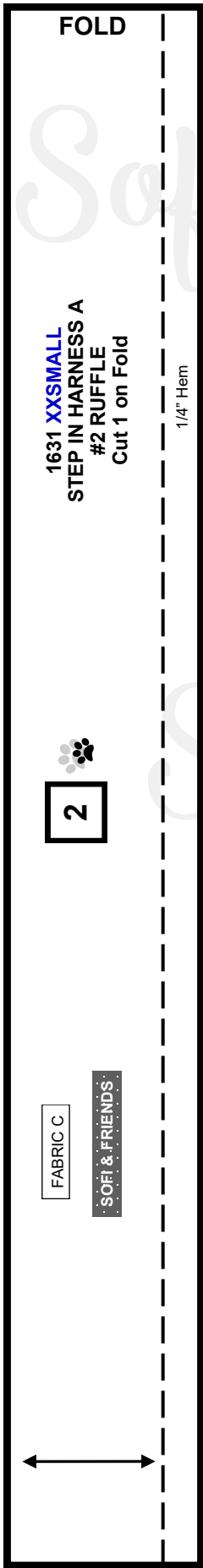

Sofi & Friends

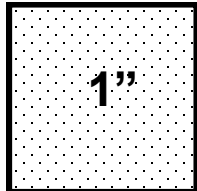
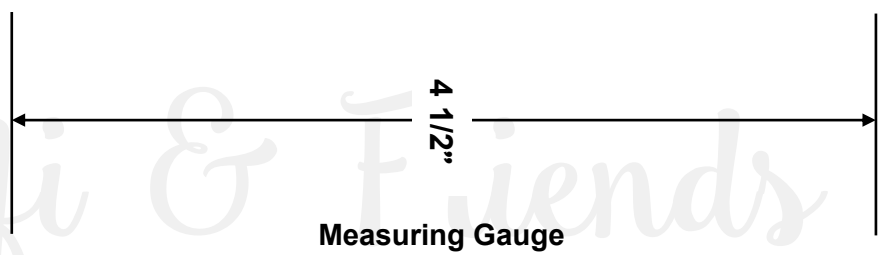

Sofi & Friends

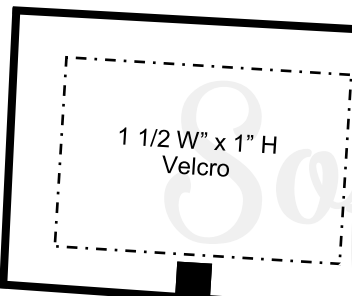
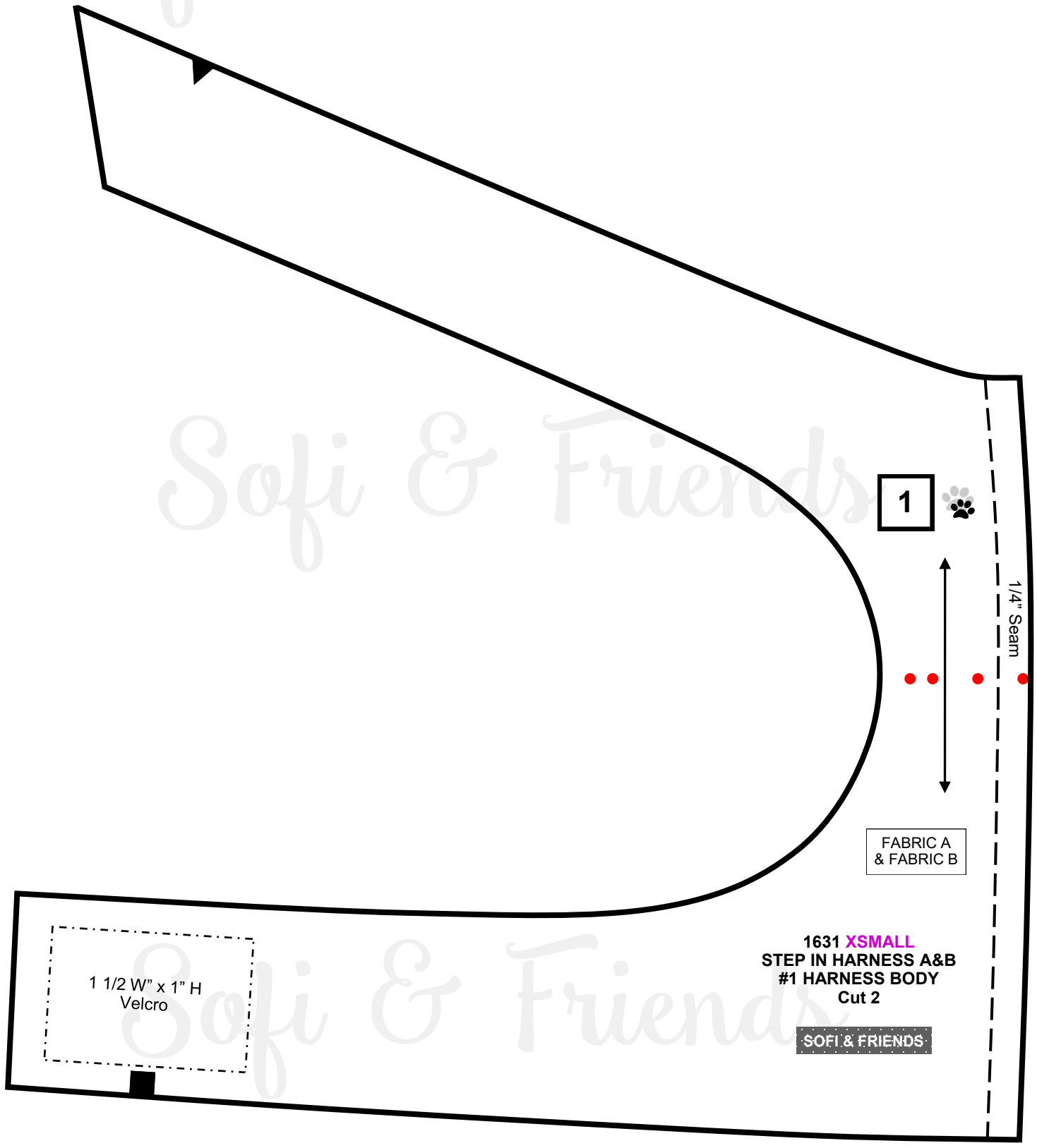

1631 XSMALL  
STEP IN HARNESS A&B  
#1 HARNESS BODY  
Cut 2





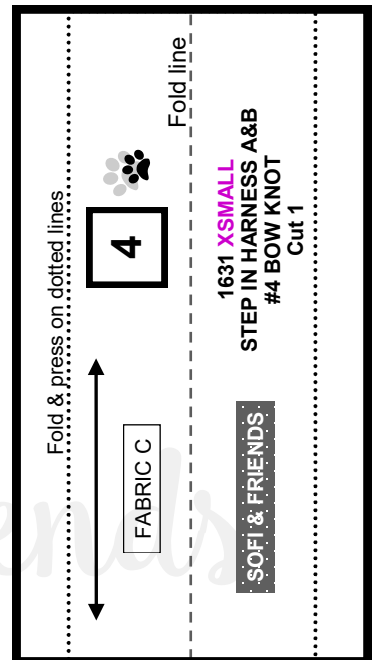
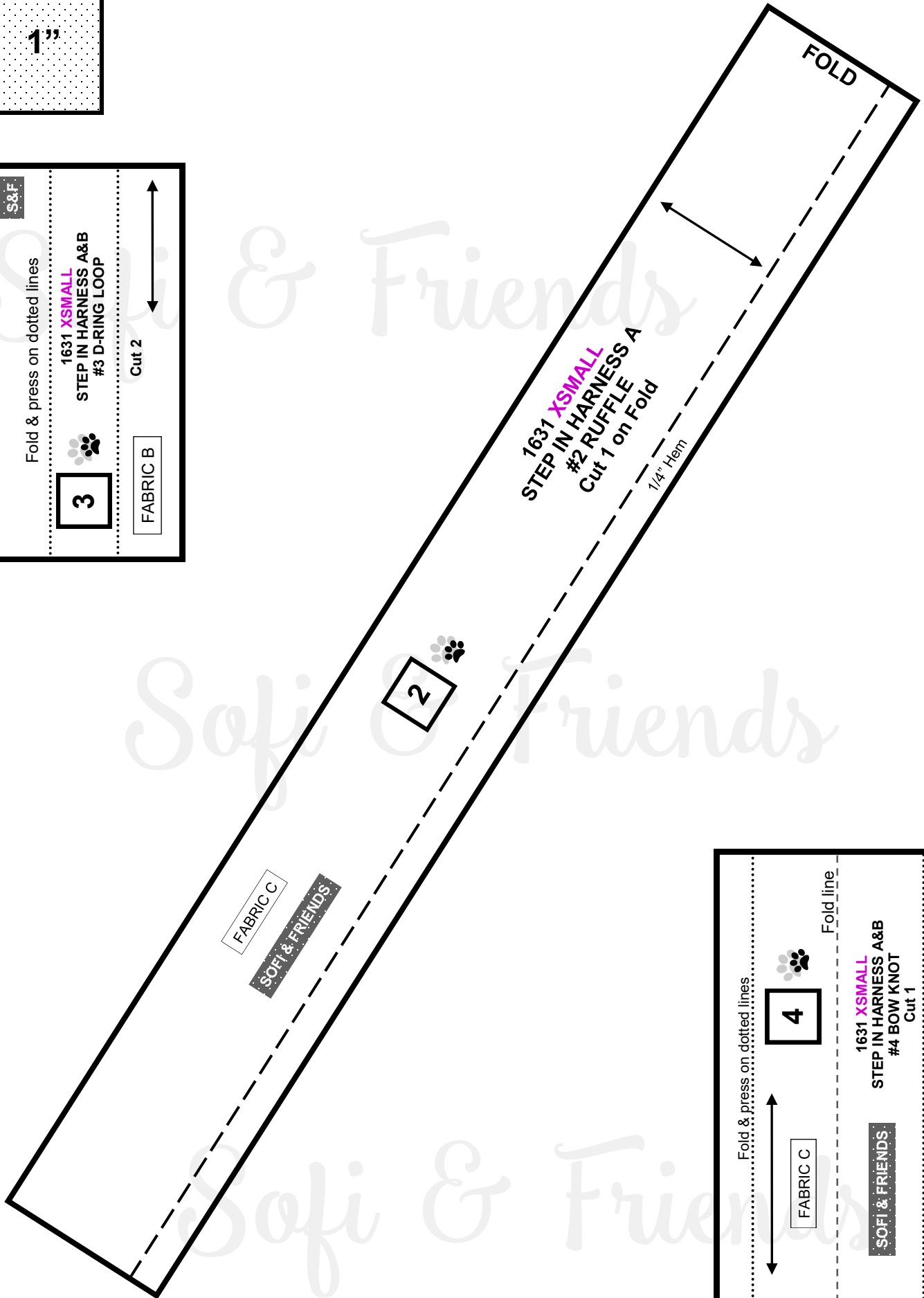
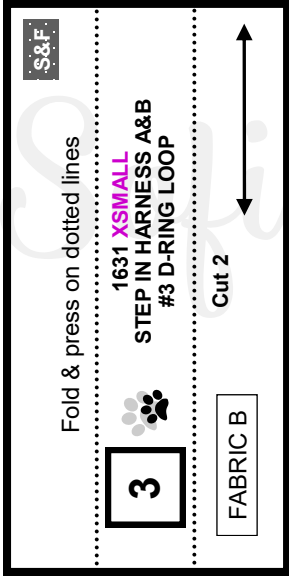

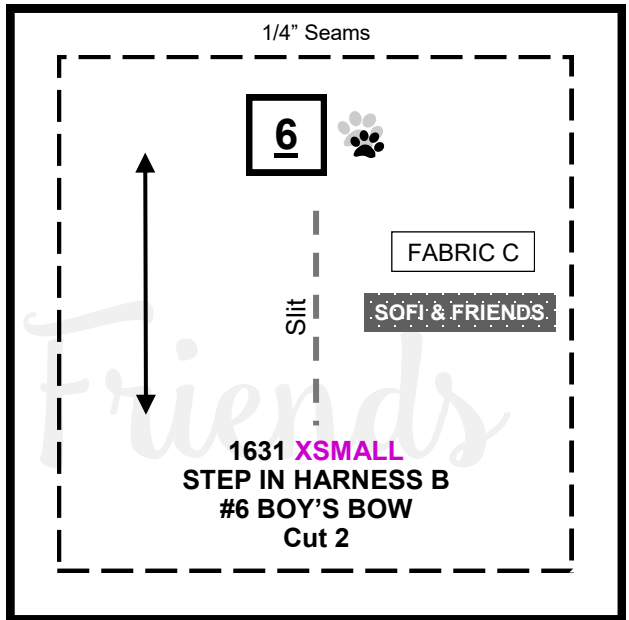
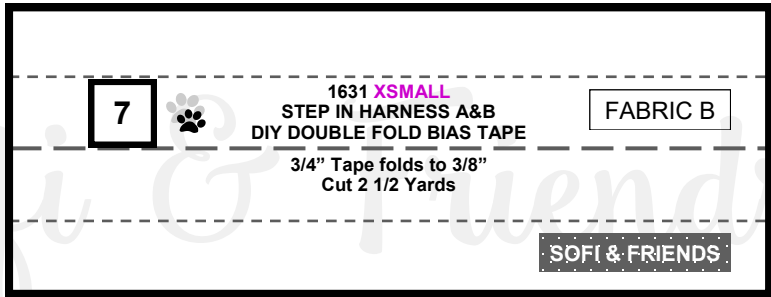
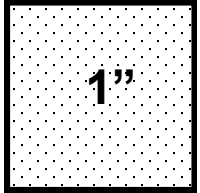
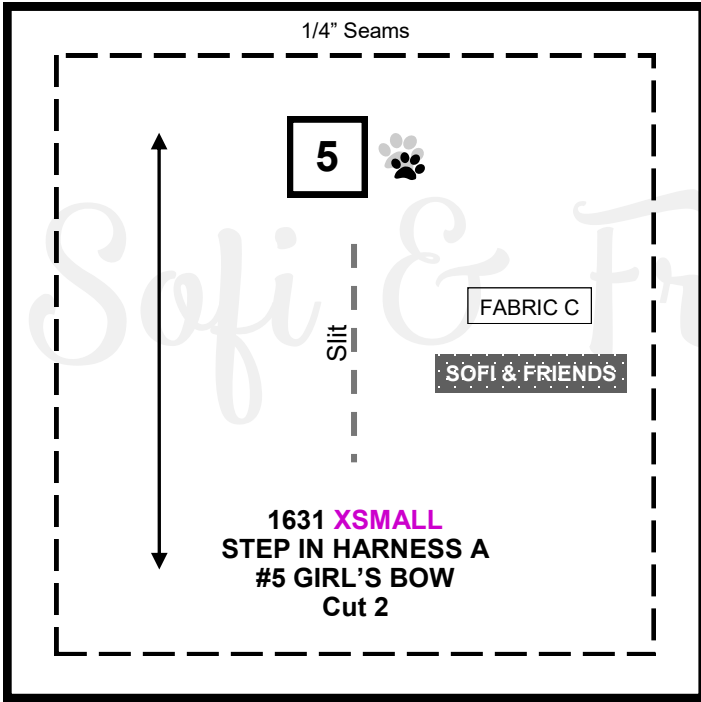

S&F

Fold & press on dotted lines

**5**

1631 SMALL  
STEP IN HARNESS A&B  
#5 D-RING LOOP

Cut 2

FABRIC B

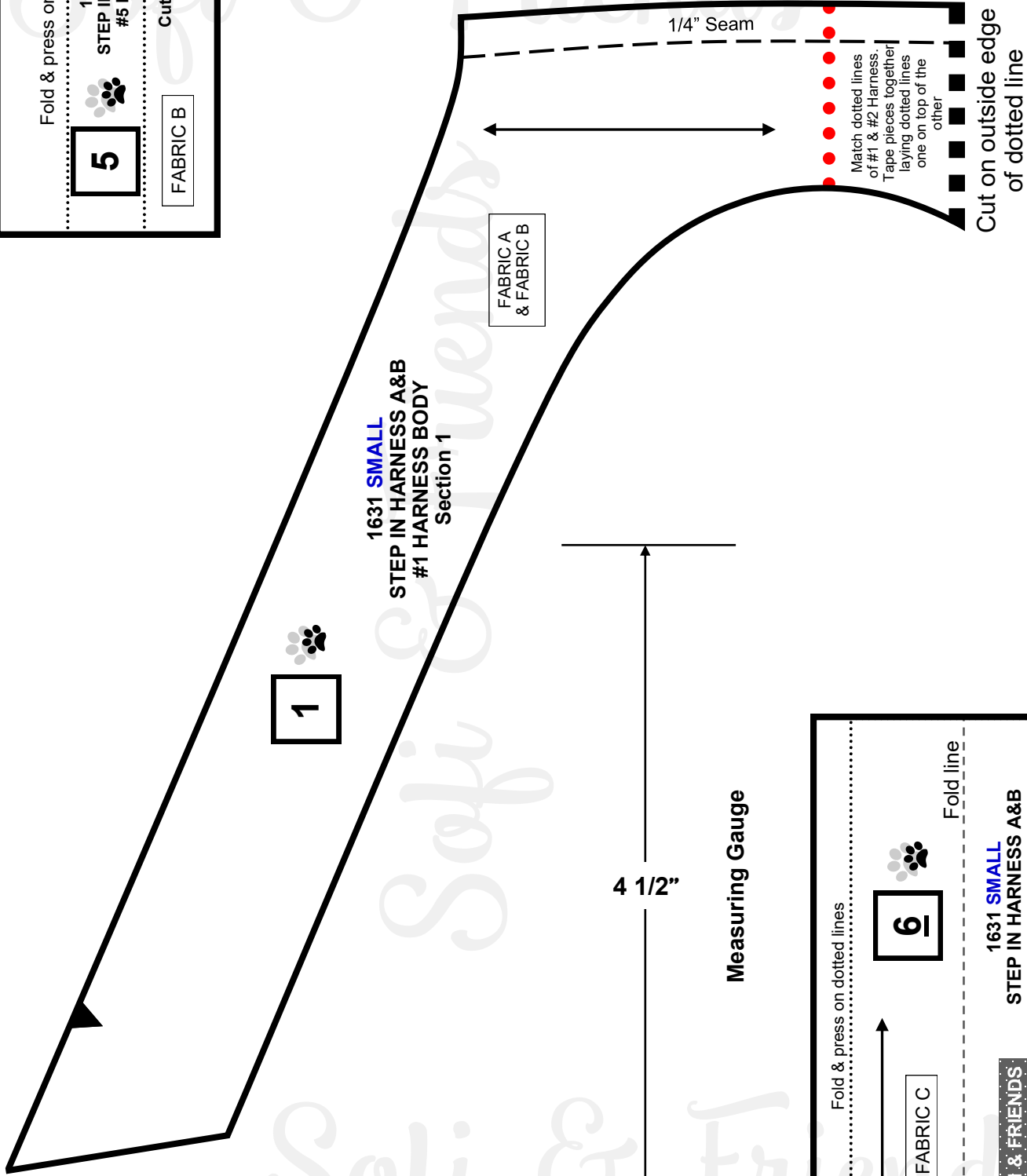
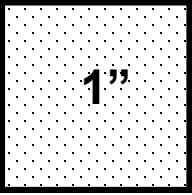

Fold & press on dotted lines

**6**

FABRIC C

Fold line

1631 SMALL  
STEP IN HARNESS A&B  
#6 BOW KNOT  
Cut 1

SOFI & FRIENDS

Sofi & Friends

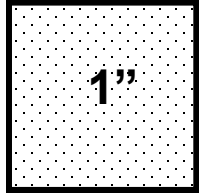
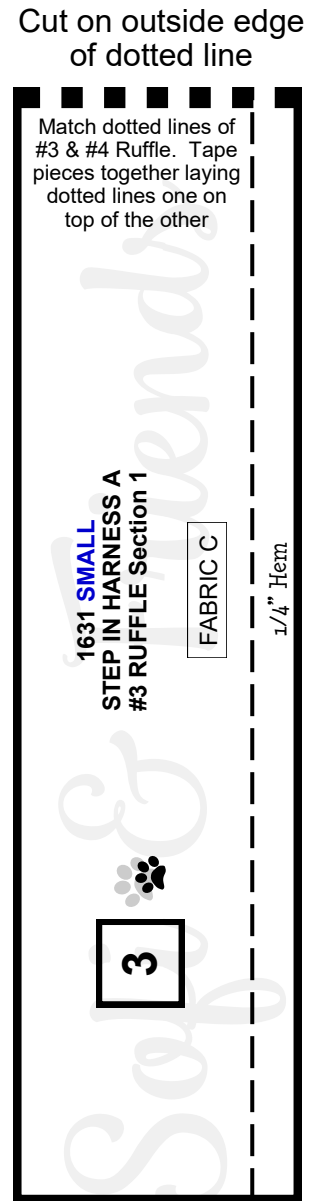
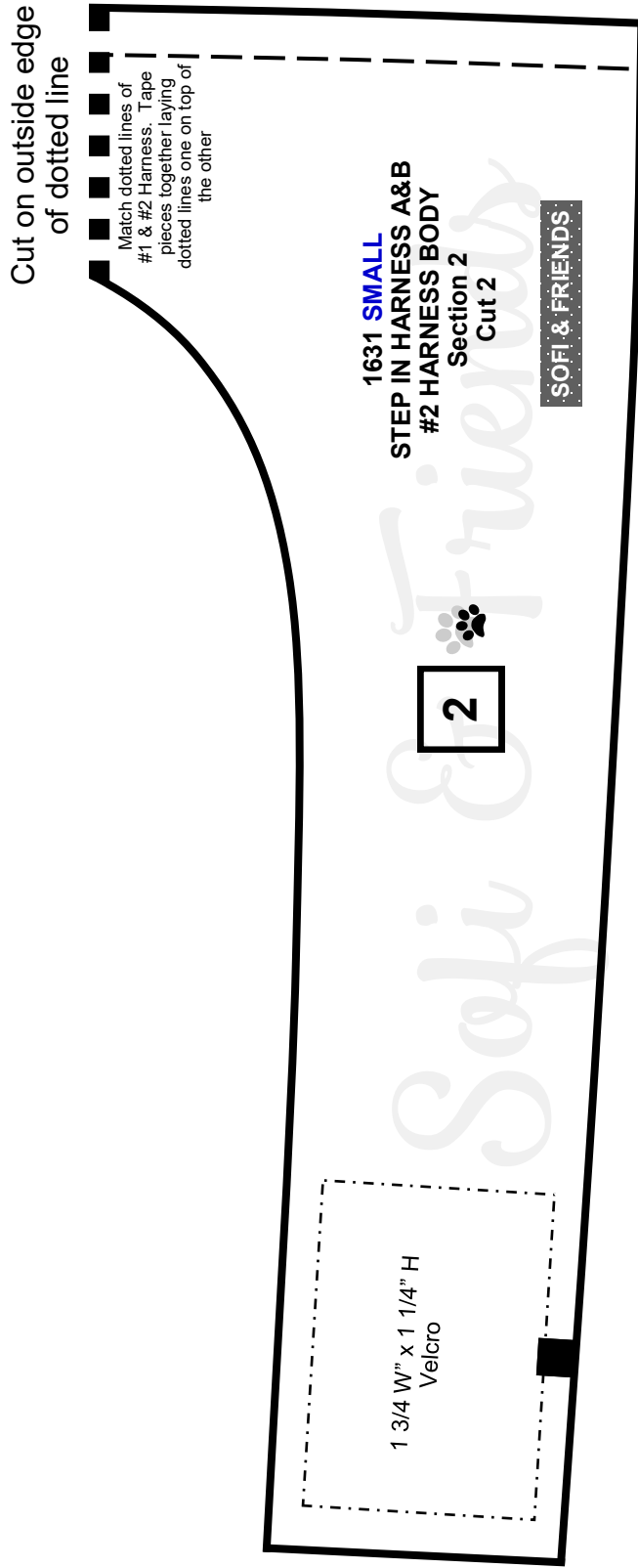
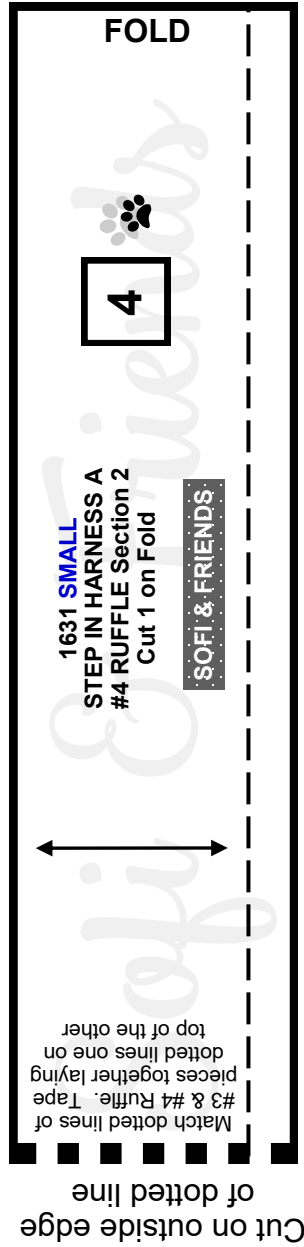

Sofi & Friends

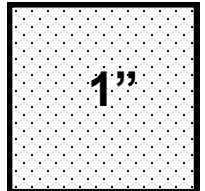
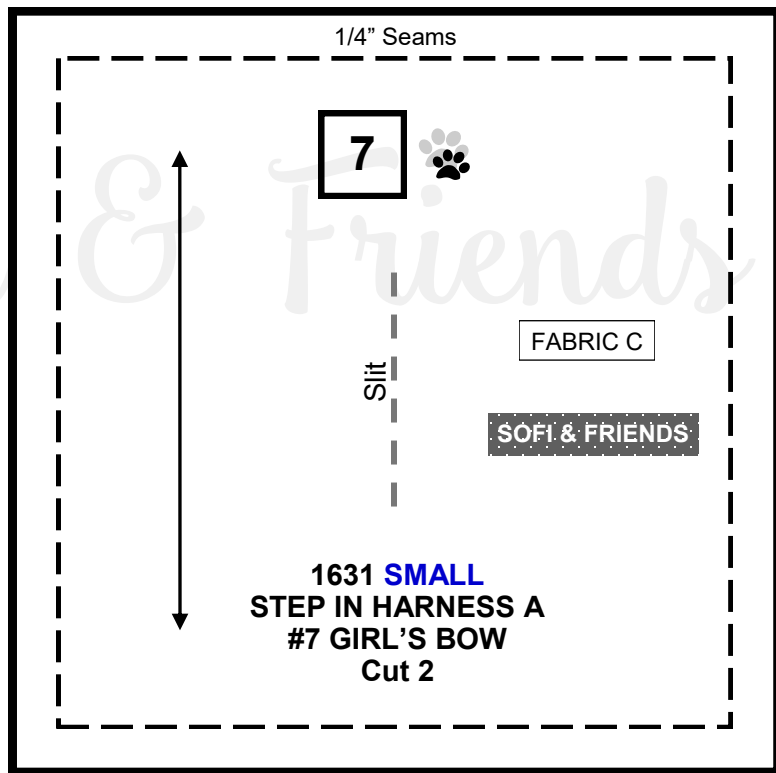

Sofi & Friends

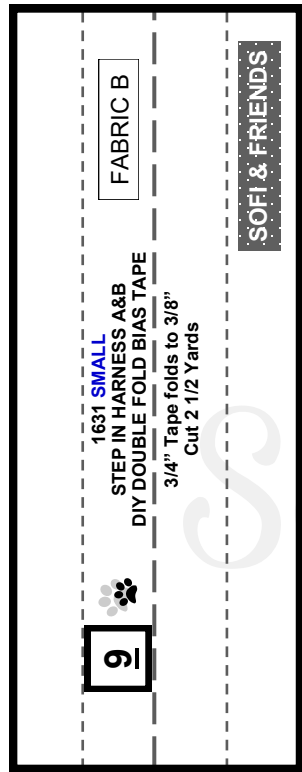

Sofi & Friends

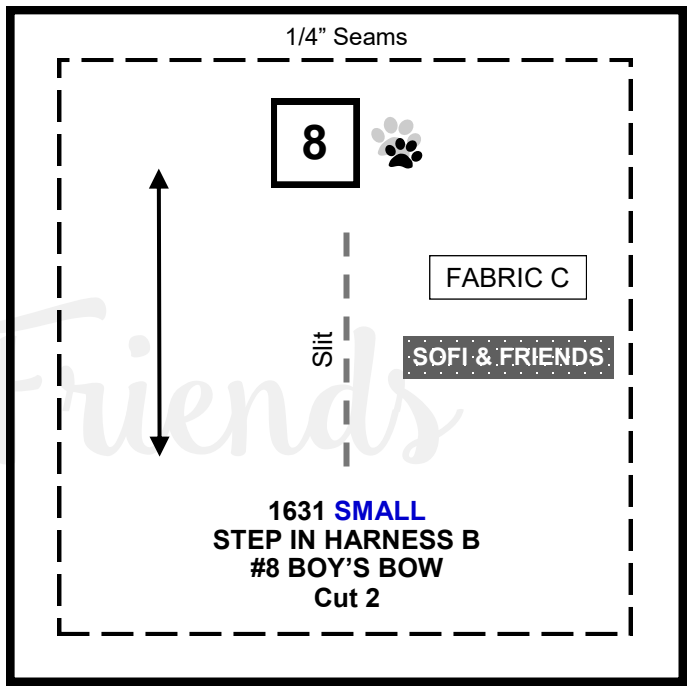

S&F

Fold & press on dotted lines

**5**

1631 MEDIUM  
STEP IN HARNESS A&B  
#5 D-RING LOOP

Cut 2

FABRIC B

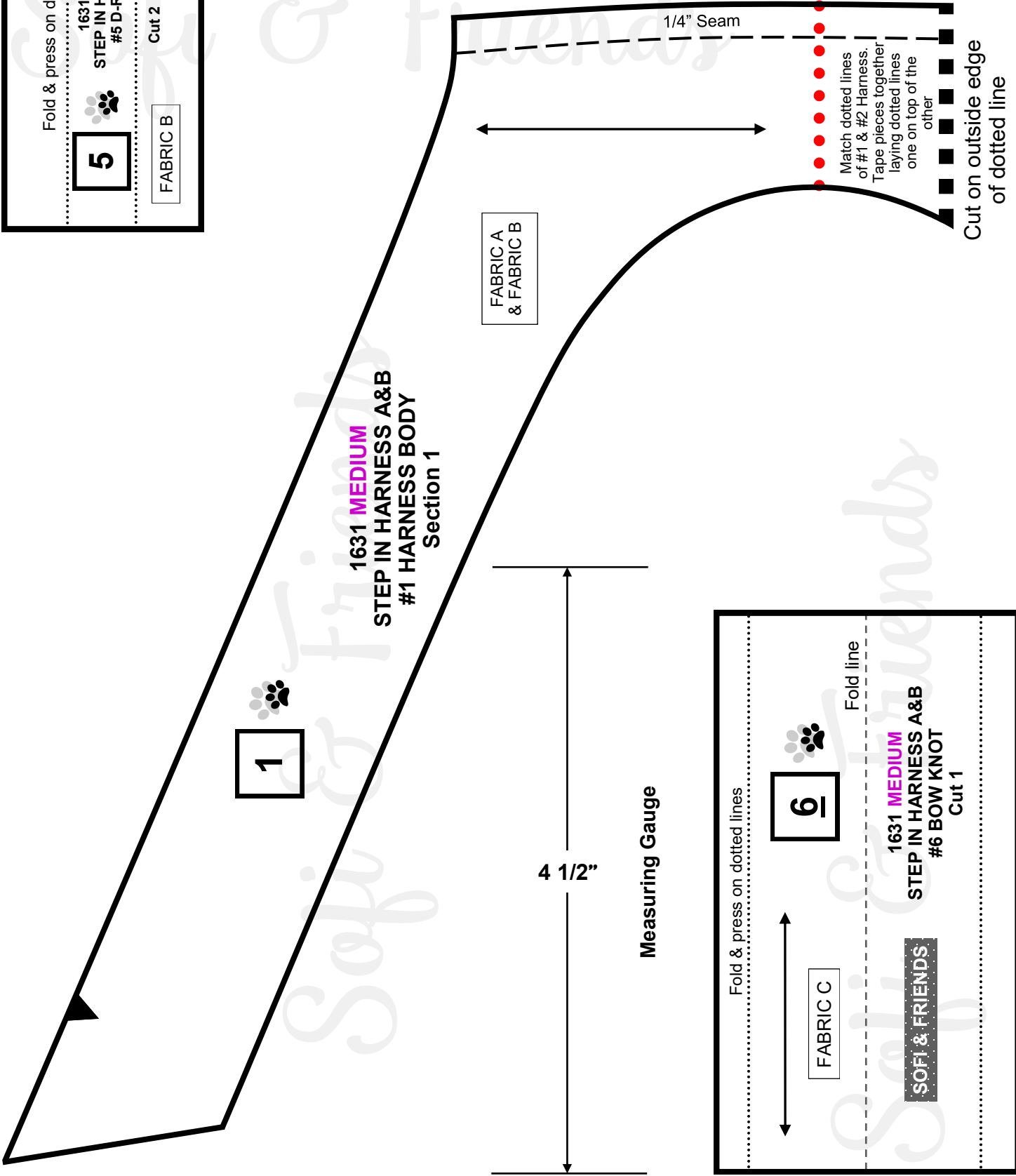
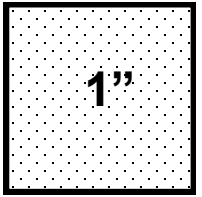

**9**

1631 MEDIUM  
STEP IN HARNESS A&B  
DIY DOUBLE FOLD BIAS TAPE  
3/4" Tape folds to 3/8"  
Cut 2 1/2 Yards

FABRIC B

SOFI & FRIENDS

Cut on outside edge of dotted line

Match dotted lines of #1 & #2 Harness. Tape pieces together laying dotted lines one on top of the other

1631 MEDIUM  
STEP IN HARNESS A&B  
#2 HARNESS BODY  
Section 2  
Cut 2

SOFI & FRIENDS

2 W" x 1 1/2" H  
Velcro

**2**

Cut on outside edge of dotted line

Match dotted lines of #3 & #4 Ruffle. Tape pieces together laying dotted lines one on top of the other

1631 MEDIUM  
STEP IN HARNESS A  
#3 RUFFLE Section 1

FABRIC C

1/4" Hem

**3**

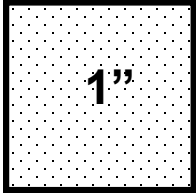

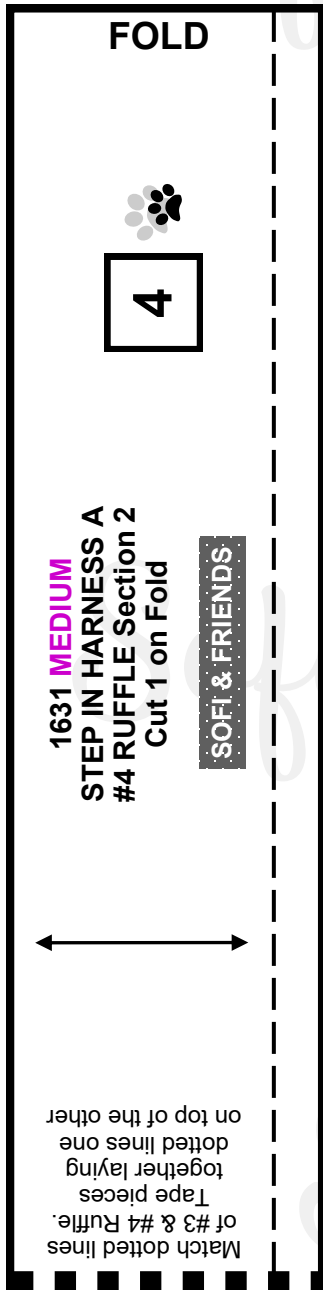

Cut on outside edge  
of dotted line

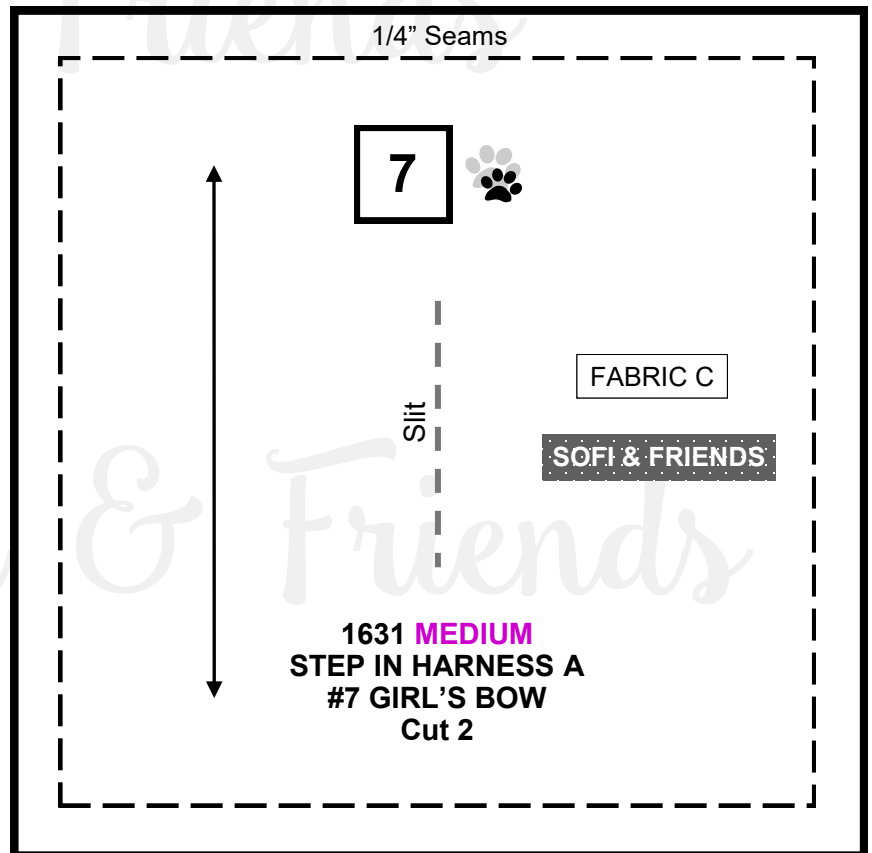
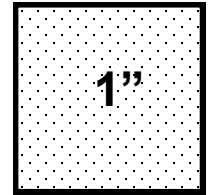
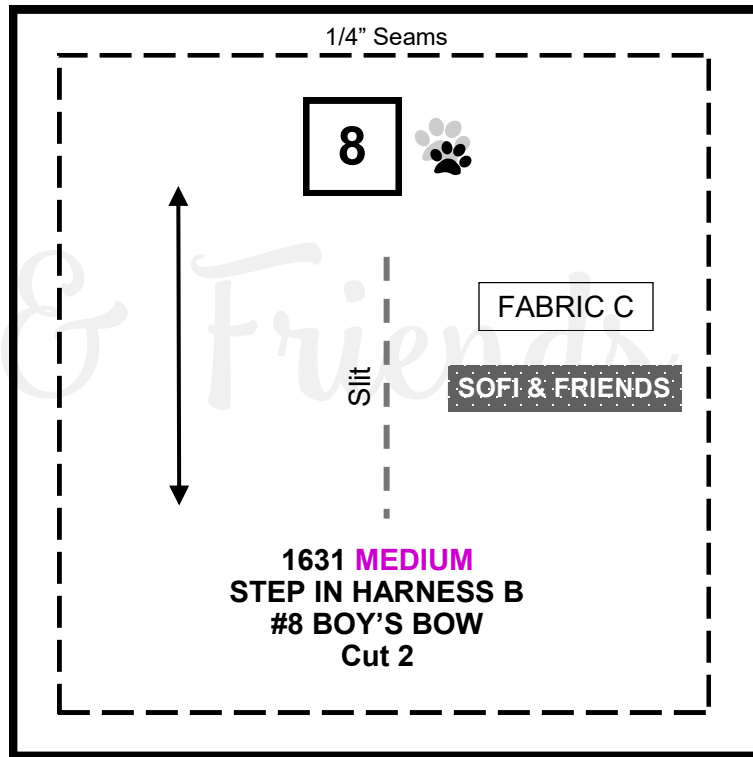



Cut on outside edge of dotted line

Match dotted lines of #2 & #3 Harness. Tape pieces together laying dotted lines one on top of the other

1631 LARGE  
STEP IN HARNESS A&B  
#3 HARNESS BODY  
Section 3

SOFI & FRIENDS

3

2 W" x 1 1/2" H  
Velcro

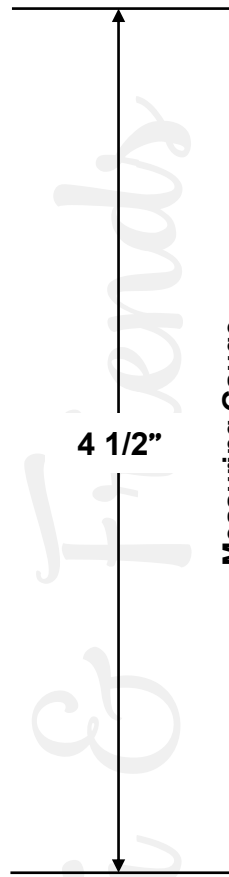

4 1/2"

Measuring Gauge



1"

Cut on outside edge of dotted line

Match dotted lines of #1 & #2 Harness. Tape pieces together laying dotted lines one on top of the other

1631 LARGE  
STEP IN HARNESS A&B  
#1 HARNESS BODY  
Section 1

1

FABRIC A  
& FABRIC B

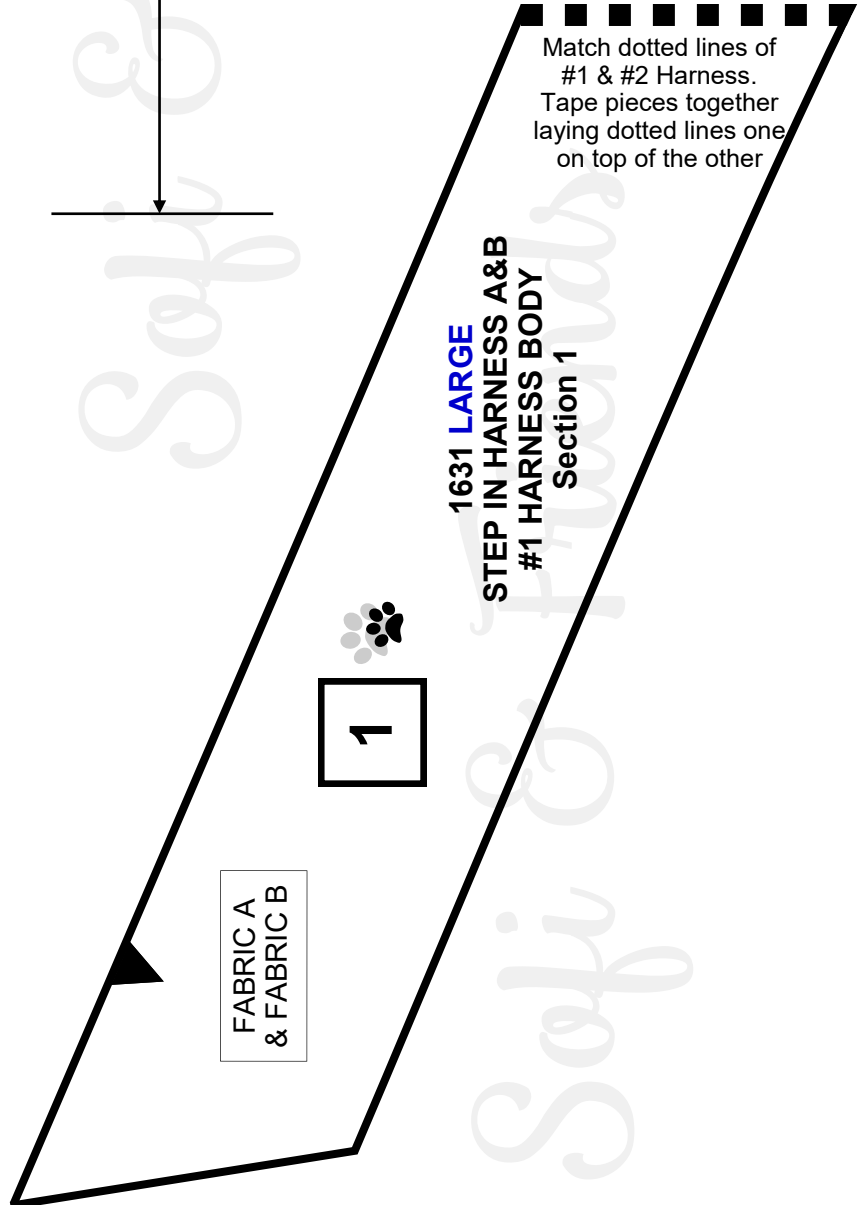

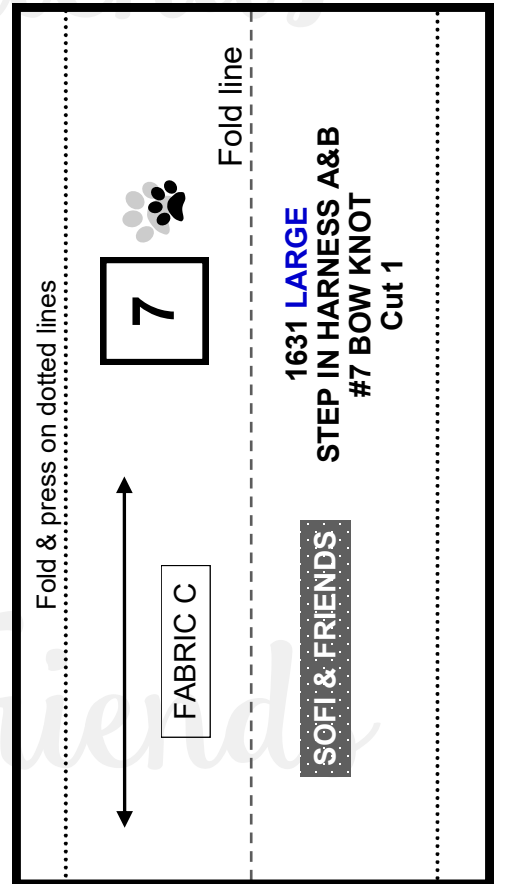
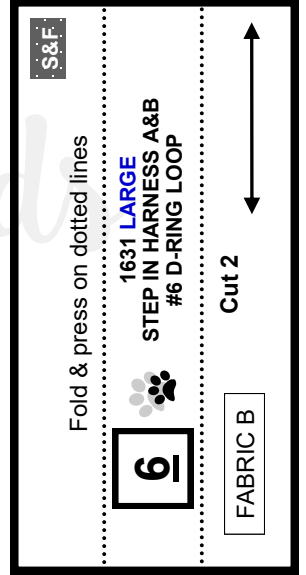
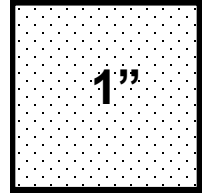
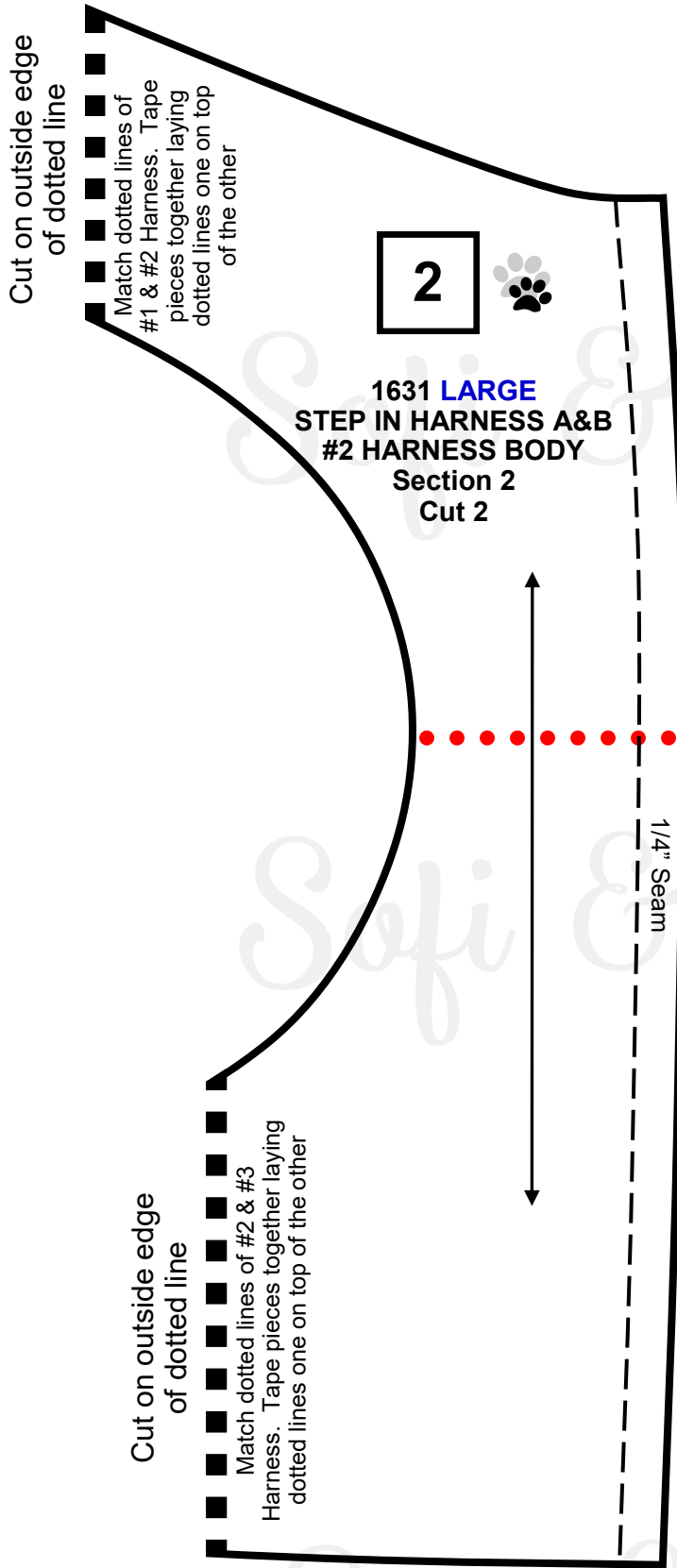

Cut on outside edge  
of dotted line

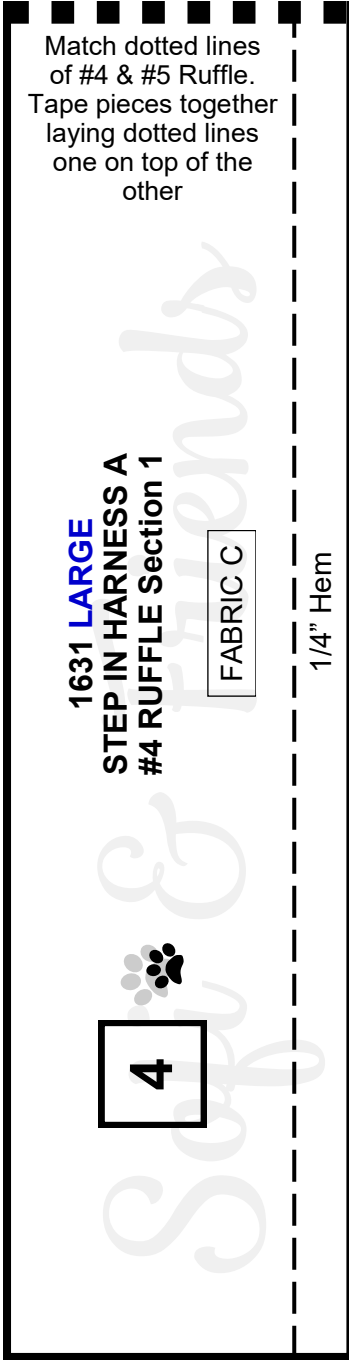

Cut on outside edge  
of dotted line

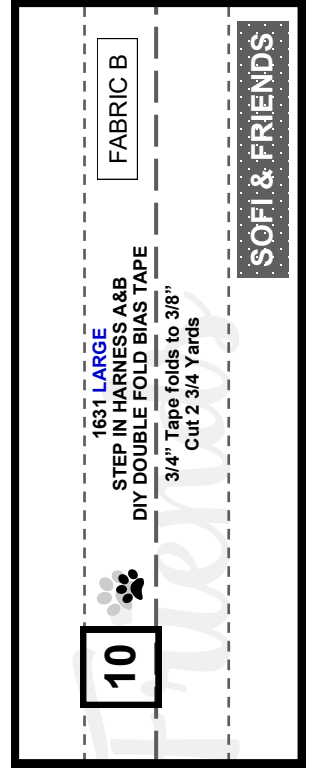
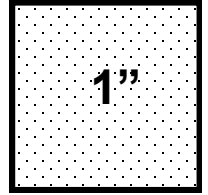

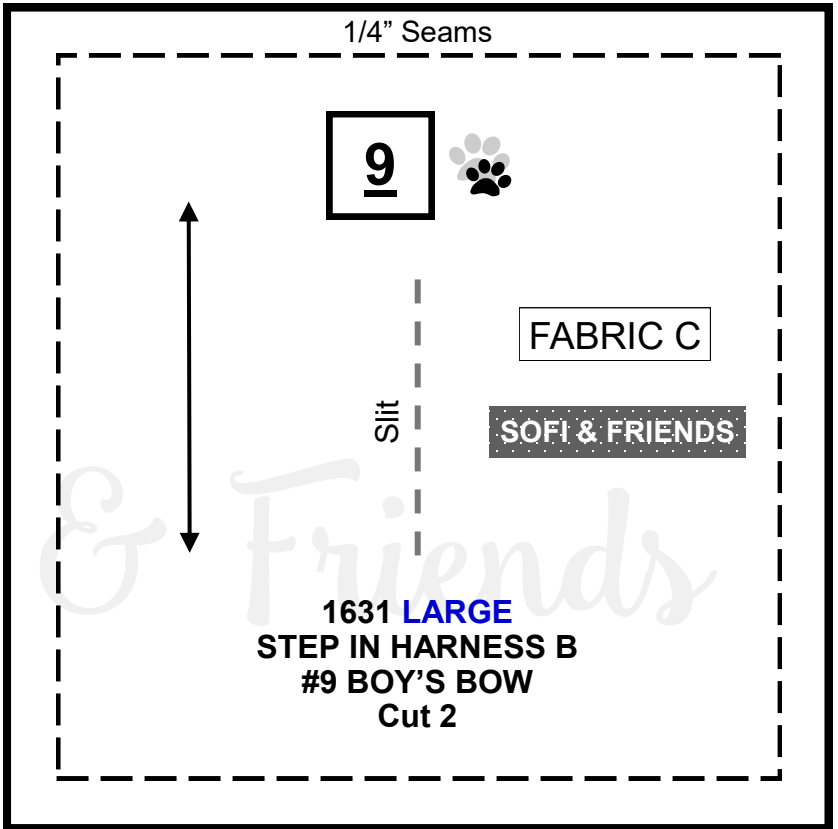
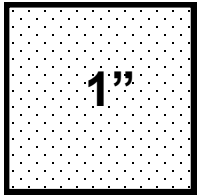
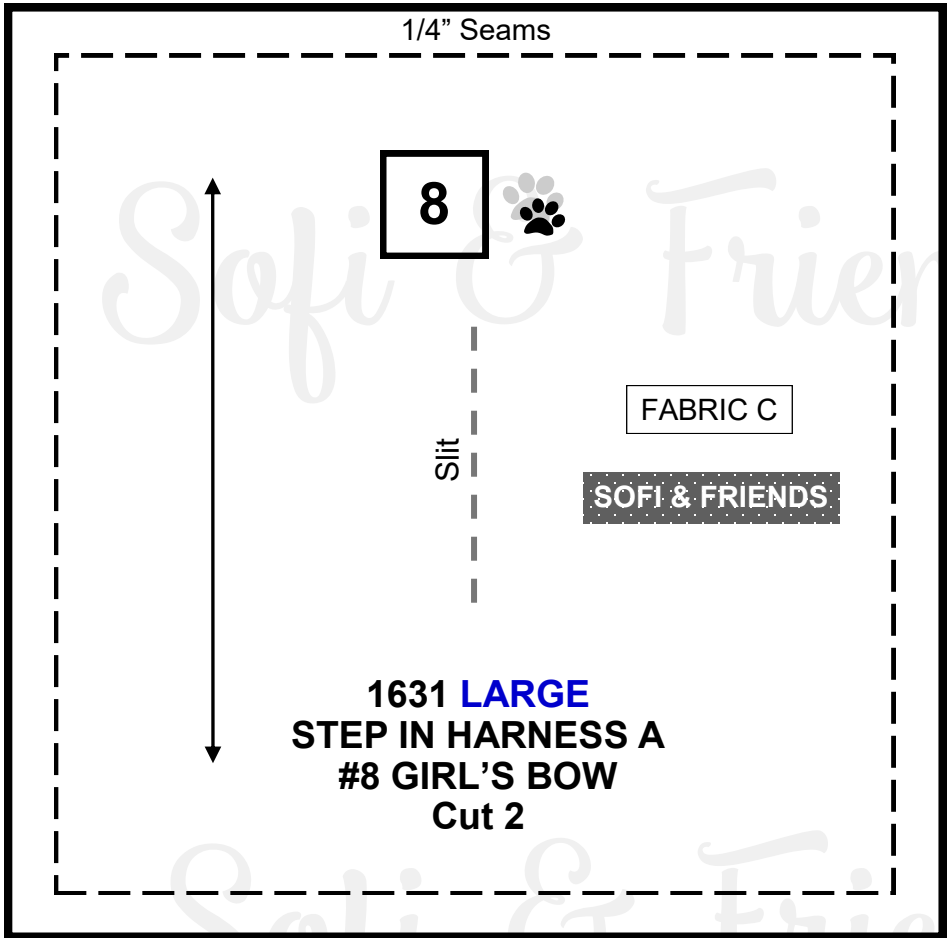

Cut on outside edge of dotted line

Match dotted lines of #2 & #3 Harness. Tape pieces together laying dotted lines one on top of the other

**1631 XLARGE**  
**STEP IN HARNESS A&B**  
**#3 HARNESS BODY**  
Section 3

SOFI & FRIENDS

3

2 1/4 W" x 1 1/2" H  
Velcro

4 1/2"

Measuring Gauge

Cut on outside edge of dotted line

Match dotted lines of #1 & #2 Harness. Tape pieces together laying dotted lines one on top of the other

**1631 XLARGE**  
**STEP IN HARNESS A&B**  
**#1 HARNESS BODY**  
Section 1

1

FABRIC A  
& FABRIC B

1"

Sofi & Friends

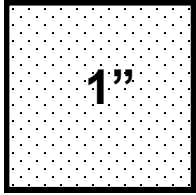
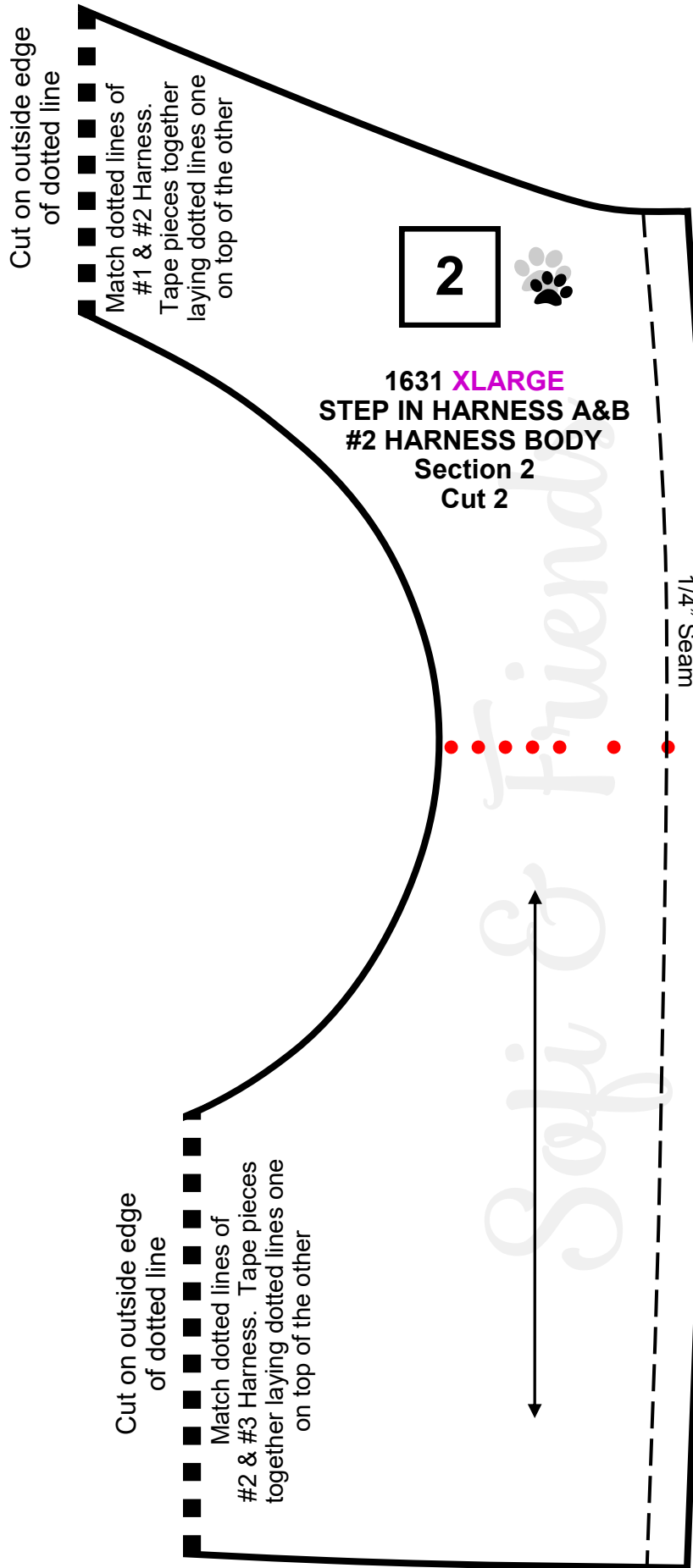

Cut on outside edge of dotted line

Match dotted lines of #4 & #5 Ruffle. Tape pieces together laying dotted lines one on top of the other

**1631 XLARGE**  
**STEP IN HARNESS A**  
**#4 RUFFLE Section 1**



FABRIC C

3/8" Hem

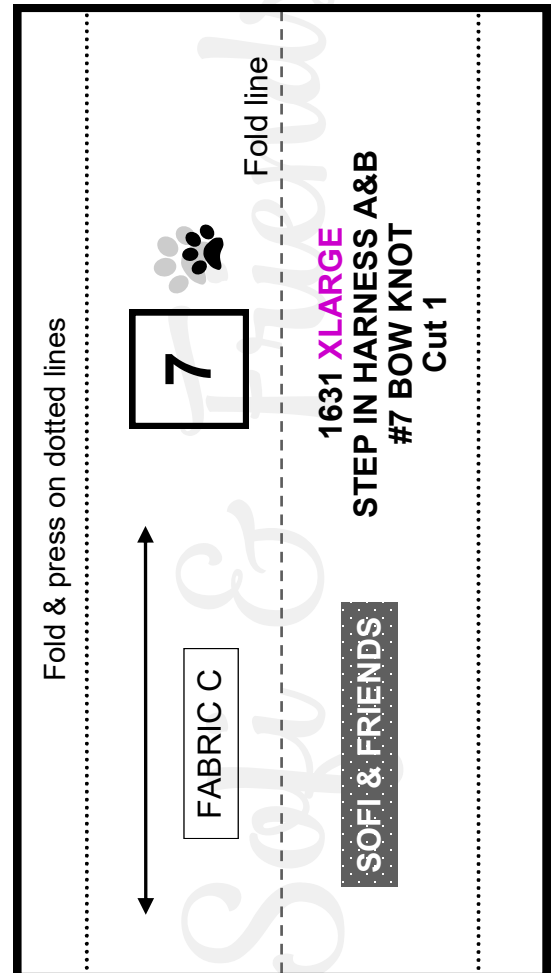
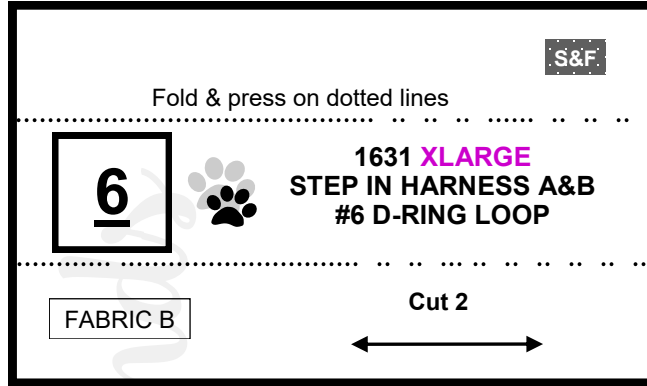
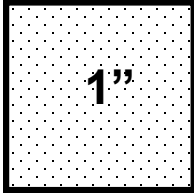

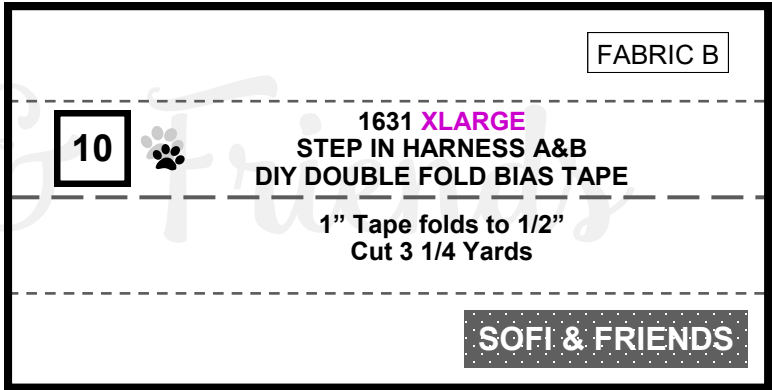
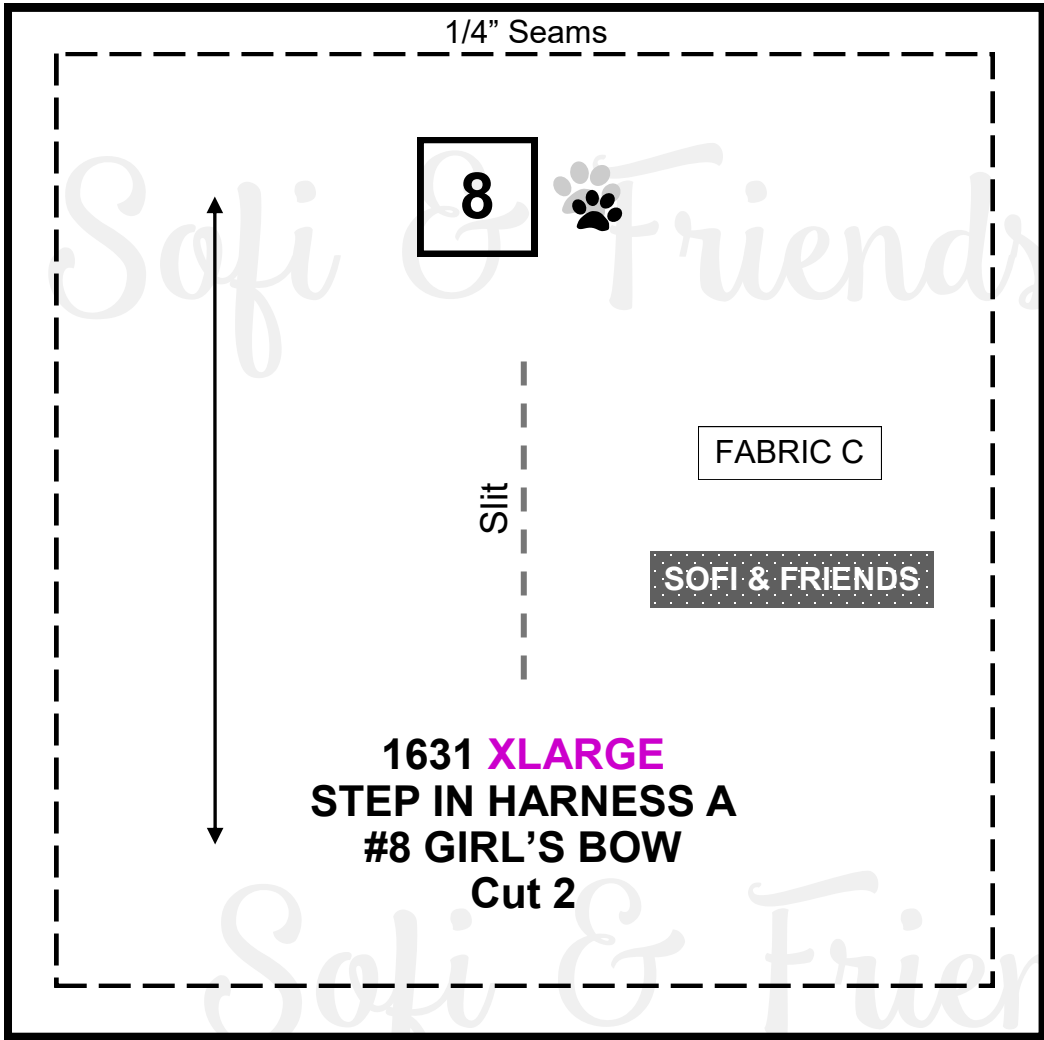



**FOLD**

**5**



**1631 XLARGE**  
**STEP IN HARNESS A**  
**#5 RUFFLE Section 2**  
Cut 1 on Fold

**SOFI & FRIENDS**

Match dotted lines of #4 & #5 Ruffle. Tape pieces together laying dotted lines one on top of the other



Cut on outside edge of dotted line

**1"**

1/4" Seams

**19**



**FABRIC C**

**SOFI & FRIENDS**

Slit

**1631 XLARGE**  
**STEP IN HARNESS B**  
**#9 BOY'S BOW**  
Cut 2



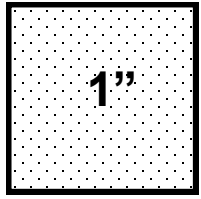

1"

Cut on outside edge of dotted line

Match dotted lines of #1 & #2 Harness. Tape pieces together laying dotted lines one on top of the other

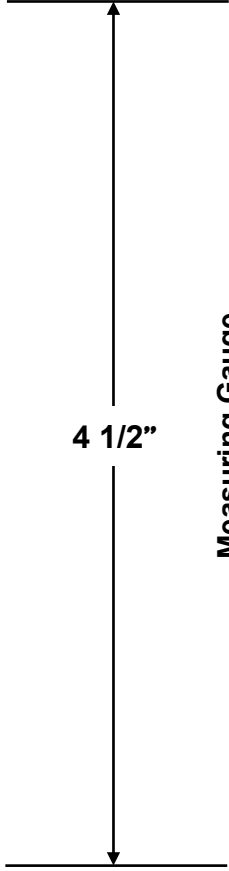

4 1/2"

Measuring Gauge

**1631 XXLARGE**  
**STEP IN HARNESS A&B**  
**#1 HARNESS BODY**  
**Section 1**



1

FABRIC A  
& FABRIC B

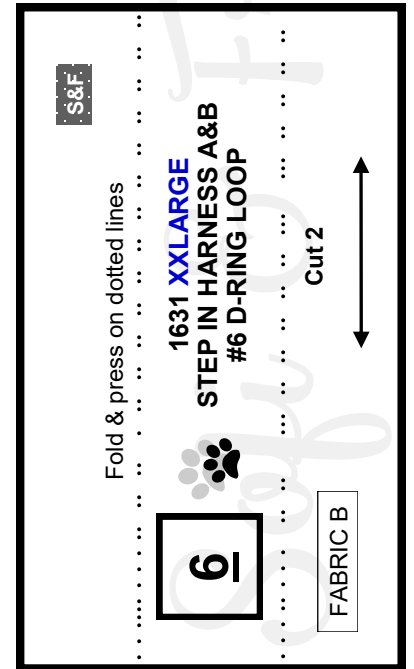
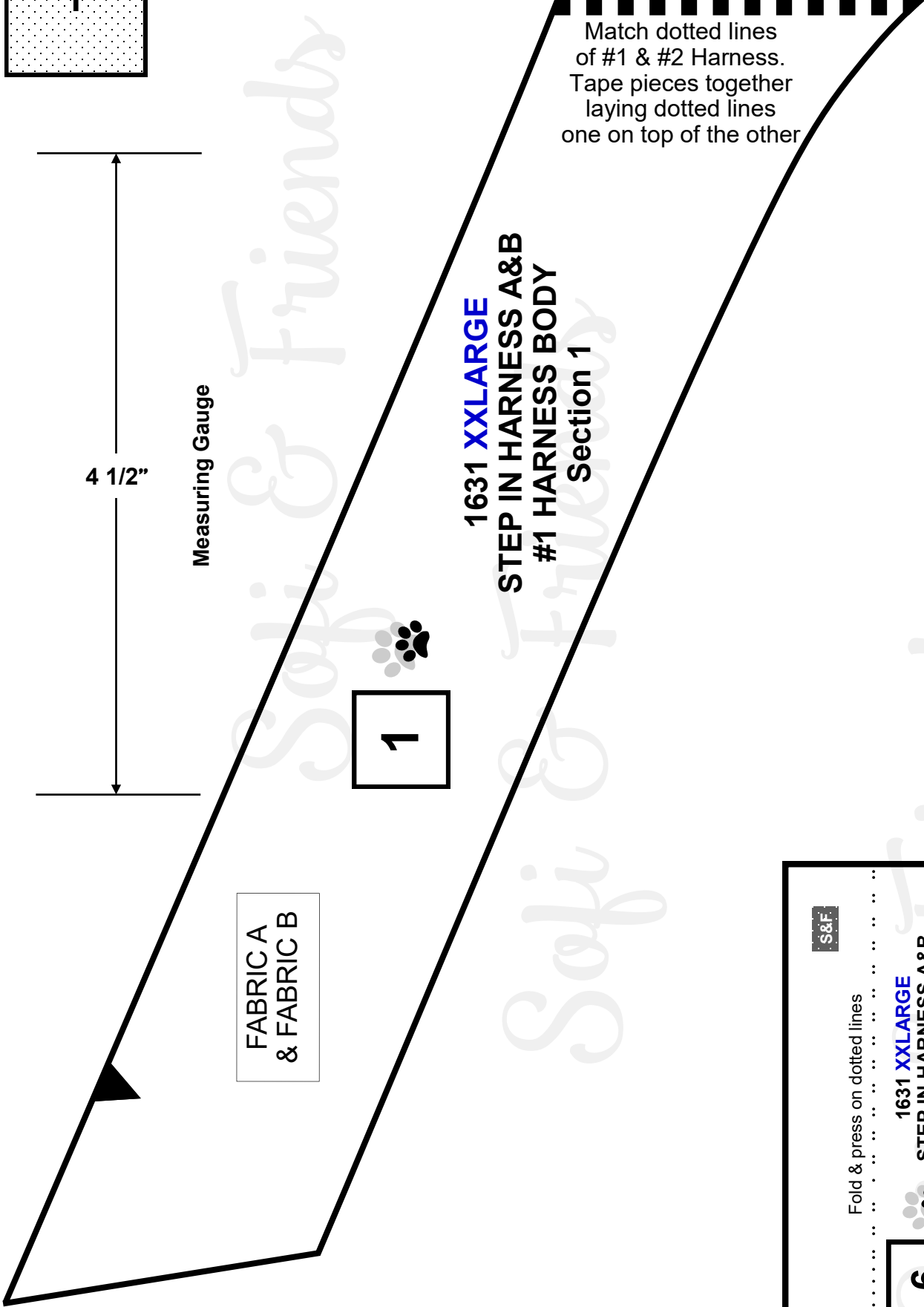

S&F

Fold & press on dotted lines



**1631 XXLARGE**  
**STEP IN HARNESS A&B**  
**#6 D-RING LOOP**

Cut 2

FABRIC B

Cut on outside edge  
of dotted line

Match dotted lines of  
#2 & #3 Harness. Tape  
pieces together laying  
dotted lines one on  
top of the other

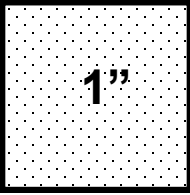

**1631 XXLARGE**  
**STEP IN HARNESS A&B**  
**#3 HARNESS BODY**  
**Section 3**

**SOFI & FRIENDS**



2 1/2 W" x 2" H  
Velcro

*Sofi & Friends*

*Sofi & Friends*

*Sofi & Friends*

Cut on outside edge of dotted line

Match dotted lines of #2 & #3 Harness. Tape pieces together laying dotted lines one on top of the other

Cut on outside edge of dotted line

Match dotted lines of #1 & #2 Harness. Tape pieces together laying dotted lines one on top of the other

2



1631 **XXLARGE**  
STEP IN HARNESS A&B  
#2 HARNESS BODY  
Section 2  
Cut 2

1/4" Seam

1"

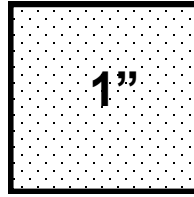

Cut on outside edge of dotted line

Match dotted lines of #4 & #5 Ruffle. Tape pieces together laying dotted lines one on top of the other

1631 **XXLARGE**  
STEP IN HARNESS A  
#4 RUFFLE Section 1

FABRIC C

3/8" Hem

4



Sofi & Friends

Cut on outside edge  
of dotted line

Match dotted lines of  
#4 & #5 Ruffle. Tape  
pieces together laying  
dotted lines one on top  
of the other



**1631 XXLARGE**  
**STEP IN HARNESS A**  
**#5 RUFFLE Section 2**  
Cut 1 on Fold

**SOFI & FRIENDS**

**5**



**FOLD**

*Sofi & Friends*

Fold & press on dotted lines



**FABRIC C**

**7**



Fold line

**1631 XXLARGE**  
**STEP IN HARNESS A&B**  
**#7 BOW KNOT**  
Cut 1

**SOFI & FRIENDS**

**1"**

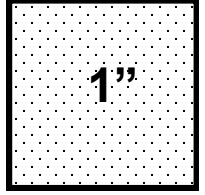

# Sofi & Friends

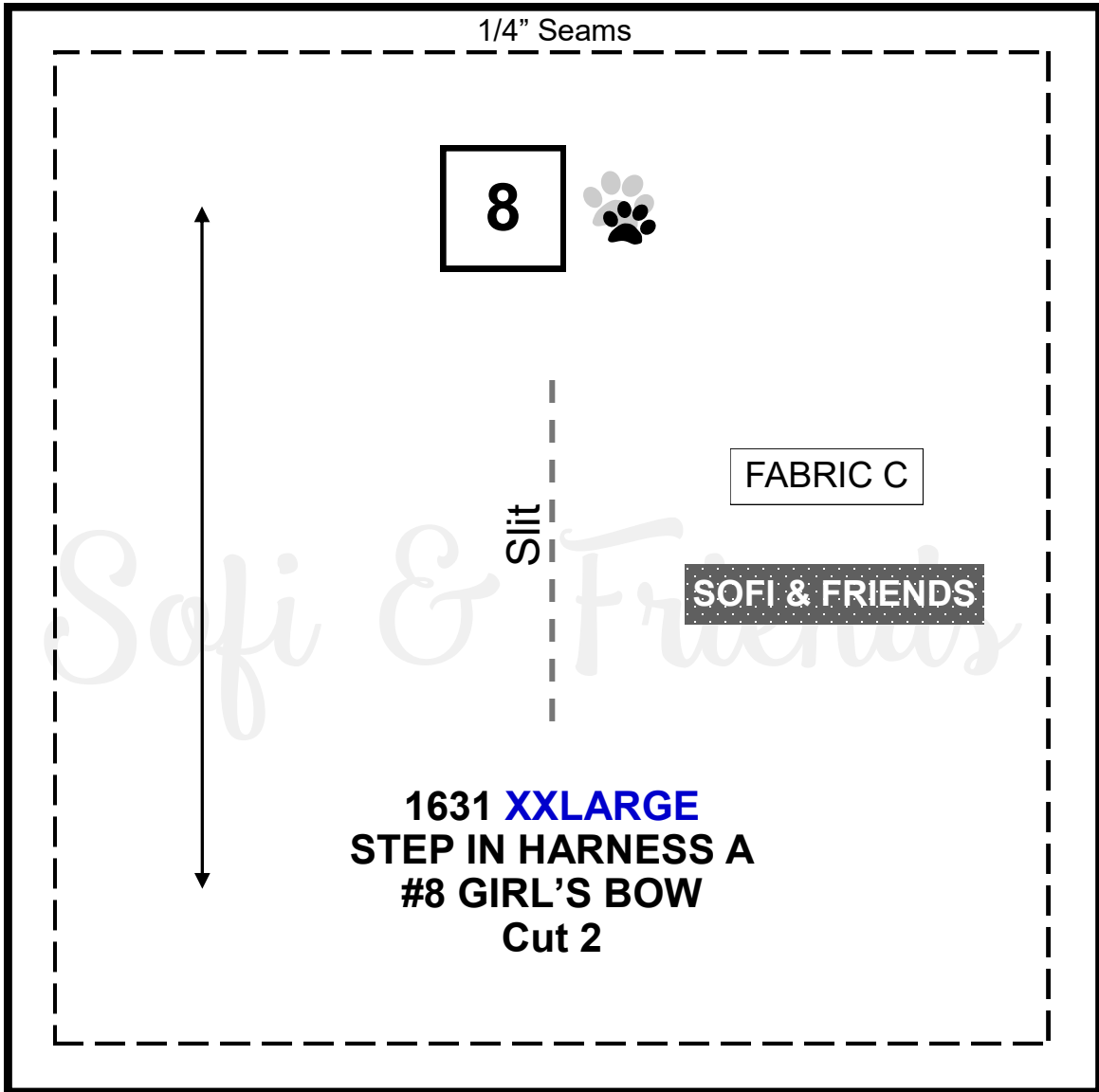
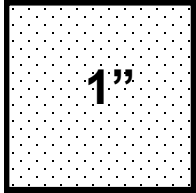

# Sofi & Friends

