

**1527**

**Size XXSm - XXLg**

Includes pattern & instructions



**FUNtastic Patterns for Little Dogs!**



**Shirt Collar Neckwear A**



**Shirt Collar Neckwear B**



© 2014 Sofi & Friends \* Sold for personal use only and not for commercial or manufacturing purposes

**To print patterns properly select the following options in Adobe Reader print section:  
Size Options - "Actual Size"  
Orientation - "Auto portrait/landscape"**

**Pattern 1527**  
**Size XXSm to XXLg**



Shirt Collar A



Shirt Collar B

**SUGGESTED FABRICS:** light to medium weight cotton & cotton blends

**NOTIONS**

**Collar A:** buttons    **Collar B:** buttons & optional chain or jewelry

**BOTH Collars:** thread; Velcro; sew on snaps

Fusible interfacing - sheerweight (XXSm to XLg) or featherweight (XXLg)

**BODY MEASUREMENTS** - See measurement image on next page

	<b>XXS</b>	<b>XS</b>	<b>SM</b>	<b>MED</b>	<b>LG</b>	<b>XLG</b>	<b>XXLG</b>
Neck	5 1/2 - 7"	6 1/2 - 8"	7 - 8 1/2"	7 3/4 - 9 1/4"	9 - 10 1/2"	10 - 11 1/2"	12 - 13 1/2"
Girth	9 1/4 - 10 3/4"	10 1/2 - 12"	12 - 13 1/2"	13 1/4 - 14 3/4"	15 - 16 3/4"	16 1/2 - 18 1/2"	19 - 21"
Length	7 3/8"+	8 1/8"+	8 7/8"+	10"+	10 5/8"+	12"+	13 3/4"+

**Measuring your Dog** - use a soft tape measure keeping it a bit loose; you should be able to slide a finger between the dog and tape

**NECK:** Measure around widest part of neck where collar sits

**GIRTH:** Measure behind front legs where chest starts

**LENGTH:** Measure from base of neck (between shoulder blades) to where tail starts

**SHIRT COLLAR A**

<b>Fabric A</b>	1/4	1/4	1/4	1/4	1/4	1/4	1/4
45" (yd)							
<b>Tie Fabric</b>	1/4	1/4	1/4	1/4	1/4	1/4	1/4
45" (yd)							
<b>Interfacing</b>	1/4	1/4	1/4	1/4	1/3	1/3	1/3
20" (yd)							

**SHIRT COLLAR B**

<b>Fabric A</b>	1/4	1/4	1/4	1/4	1/4	1/4	1/4
45" (yd)							
<b>Bow Fabric</b>	Scrap	Scrap	Scrap	Scrap	Scrap	Scrap	Scrap
Scrap piece							
<b>Interfacing</b>	1/4	1/4	1/4	1/4	1/3	1/3	1/3
20" (yd)							

**Finished**

<b>Tie</b>							
<b>Length</b>	3 3/8"	3 1/2"	3 7/8"	4 1/4"	4 3/4"	5 1/4"	5 7/8"
Approx.							

Use 1/4" (XXSm to Lg) or 3/8" (XLg to XXLg) seam allowance on all seams unless otherwise noted. Press all seam allowances as noted in instructions.

### Pattern Markings

←→ Grainline - Place on straight grain of fabric, parallel to selvage or fold.

FOLD Place line on fold of fabric.

### GLOSSARY

EASESTITCH-Stitch along seamline, using long machine stitches. Pull thread ends to adjust the fit.

GATHER-Stitch along seamline using long machine stitches. Pull thread ends to adjust the fit.

REINFORCE-Stitch again along seamline using small machine stitches.

TOPSTITCH-On outside, stitch 1/8" to 3/16" from seam depending on size of pattern.

CLIP CURVES-Notch inside curves and clip outside curves.

TRIM CORNERS-Trim excess fabric from outside corners.

FINISH EDGE-Use a zigzag stitch, or stitch of your choice, to finish raw edge of fabric.

### TIPS

Use knitting needle to **gently** turn square corners right side out.

Overlap Velcro right over left and place softer side of Velcro on right side of garment. It will be softer for the dog if Velcro comes into contact with the skin.

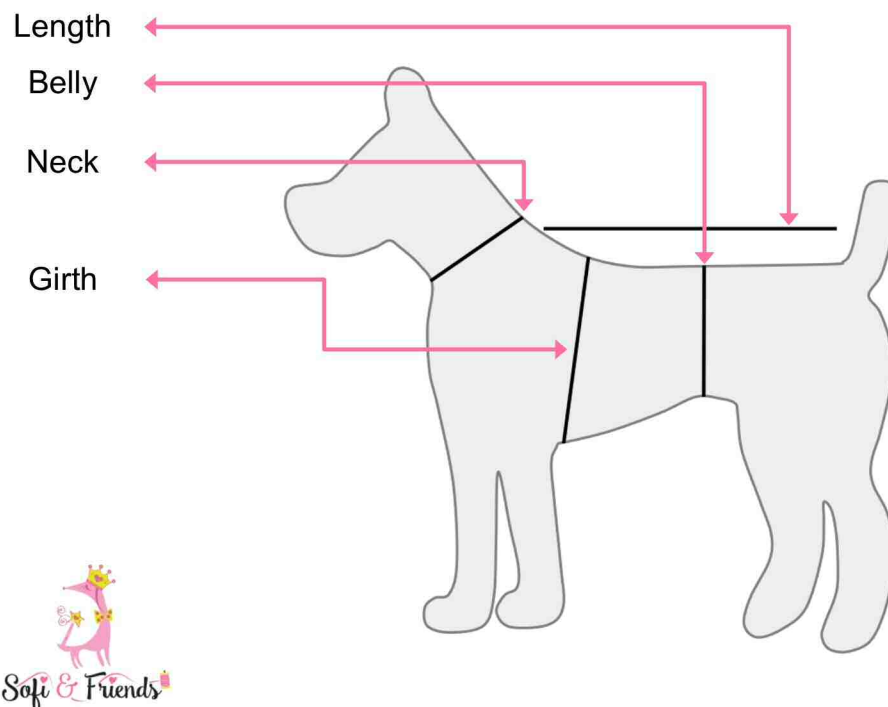

The following instructions demonstrate how to alter this pattern to fit your dog perfectly. Begin with the Body Measurements noted on the 1st page of the pattern. When selecting a size choose one that will give your dog the best overall fit. Girth is most important, then Neck and then Length.

**Altering Neck & Girth**

- 1) The quickest method is to add to or trim from the Velcro length. The pattern indicates the width and length of Velcro.
- 2) The second method involves altering the pattern as follows.
  - Patterns are made to fit comfortably the largest number on the size range.
  - For example, the neck range on a size Large pattern is 9" to 10 1/2".
  - The pattern is designed to fit perfectly on a dog with a 10 1/2" neck.
  - If your dog's neck size is 9 1/2", subtract 9 1/2" from 10 1/2" equaling 1.
  - The overall neck measurement needs to be 1" less, so the neck tab would be trimmed 1/2".

Add to or trim from RED lines to alter neck



**Altering Length**

To shorten/lengthen tie add to or trim from RED dotted lines.

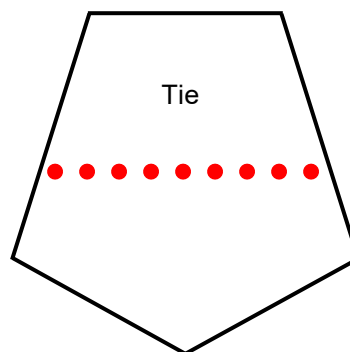

**SEWING INSTRUCTIONS**

- 1) Following manufacturers instructions apply interfacing to Collars making sure interfacing is applied to one set of collars that are opposite each other. (View A)
- 2) RIGHT sides together sew Collars leaving neck edges open. (View A)
- 3) Trim corners and clip curves. (View A)
- 4) Turn Collars right side out. Press & topstitch. (View B)
- 5) Following manufacturer's instructions apply interfacing to Neckband.
- 6) RIGHT sides together baste Collars to Neckband centering each Collar between single notches. (View C)
- 7) RIGHT side down pin Neckband lining over top of Collars matching Neckband edges. (View D)
- 8) Sew through all thicknesses leaving open between double notches. (View D)
- 9) Trim corners. (View D)

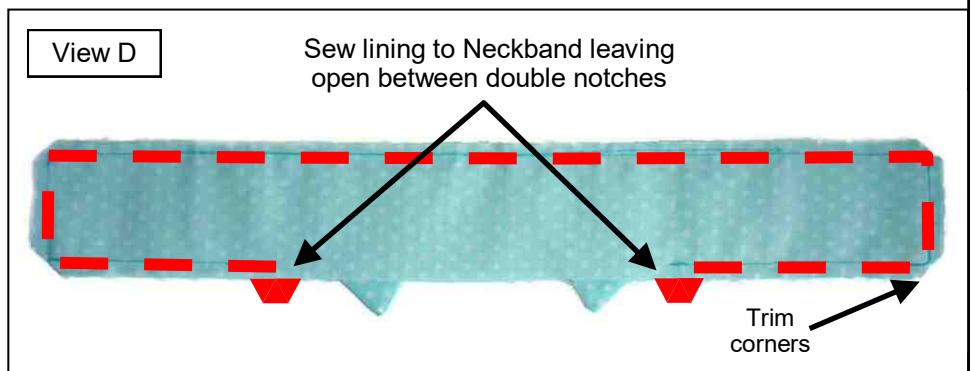
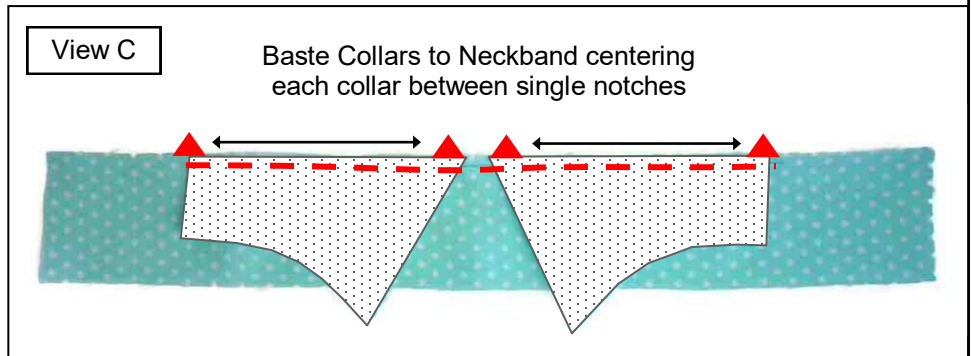
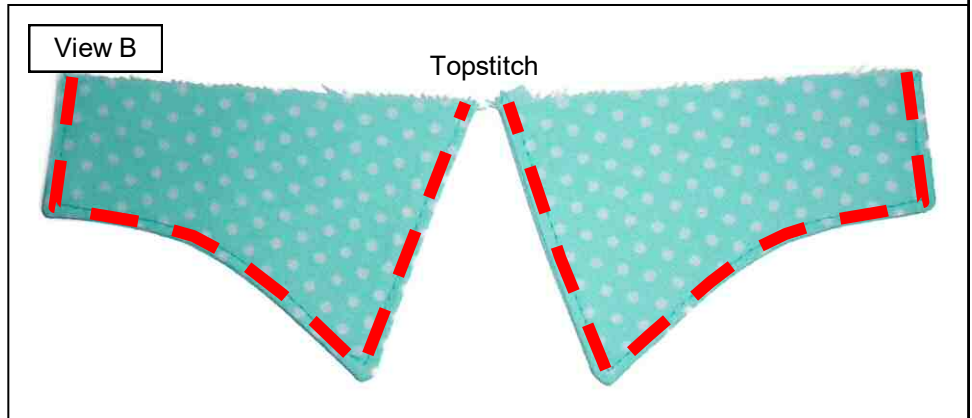
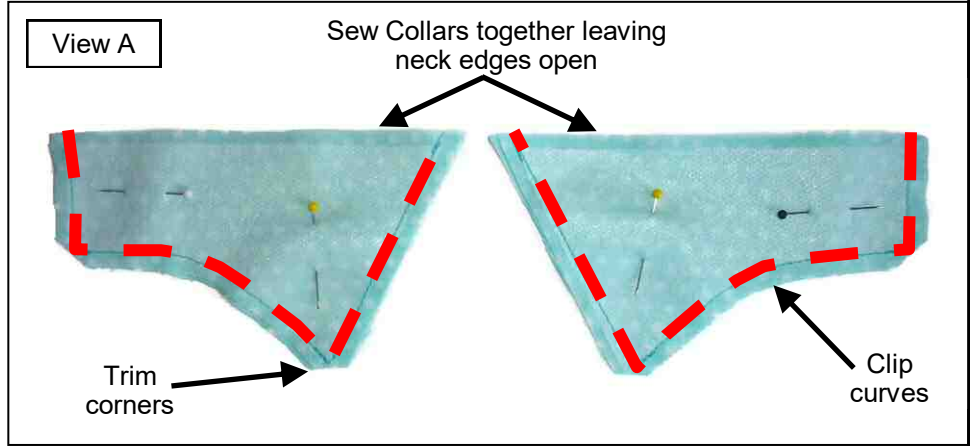

10) Turn Neckband right side out and press.

11) Fold and press Neckband hem on both sides of opening. (View E)

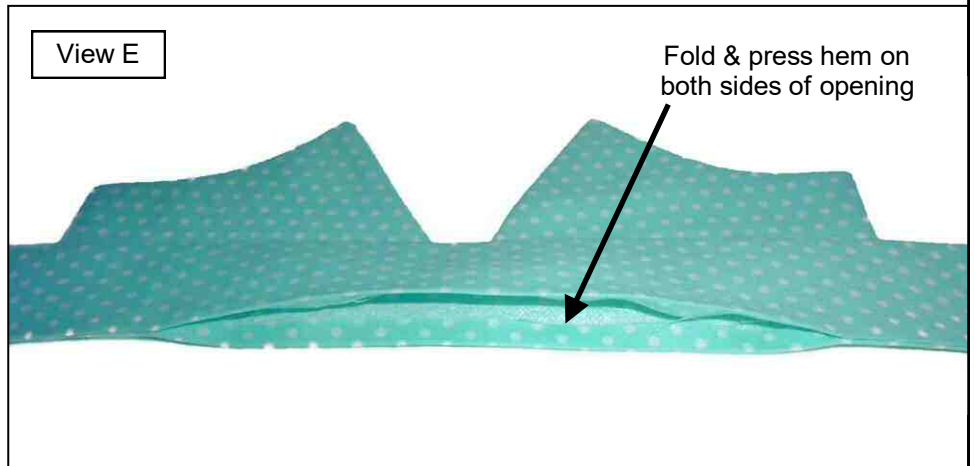

12) Topstitch Neckband catching opening. (View F)

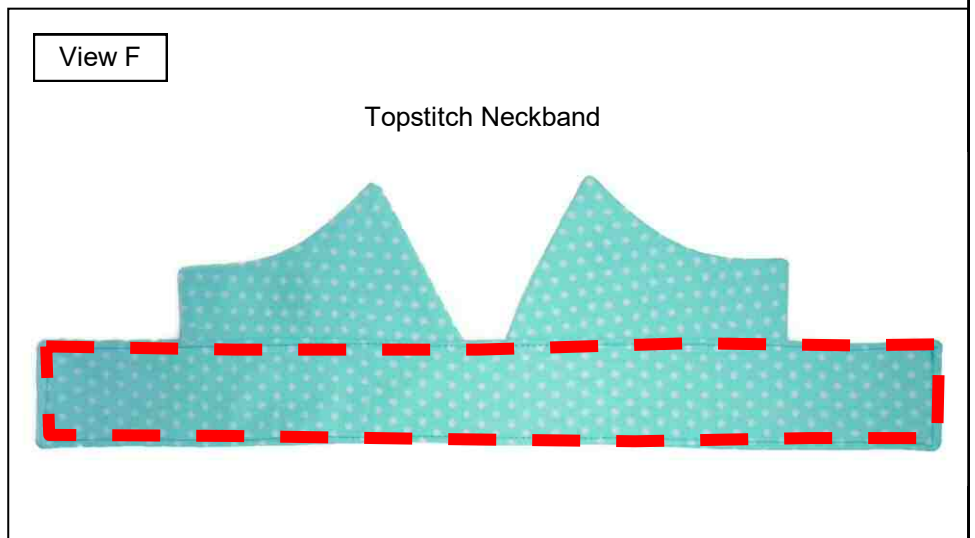

13) Fold and press Collars over Neckband. (View G)

14) Hand sew outside Collar points to Neckband with 2-3 stitches. (View G)

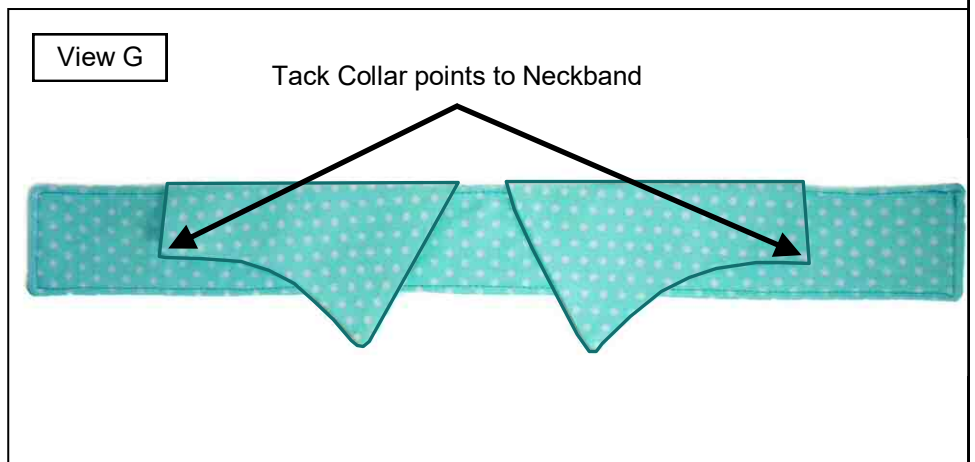



15) Sew Velcro to Neckband overlapping right over left. Sew soft side (loop side) of Velcro to right side of Neckband. Sew rough side (hook side) of Velcro to left side of Neckband. This will prevent the rough side of the Velcro from coming into contact with the dog's skin and possibly causing irritation. (View H)

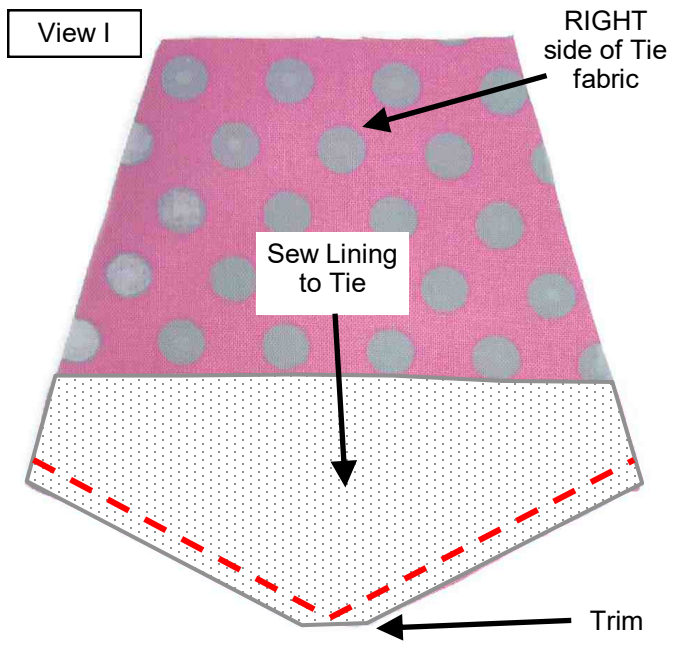
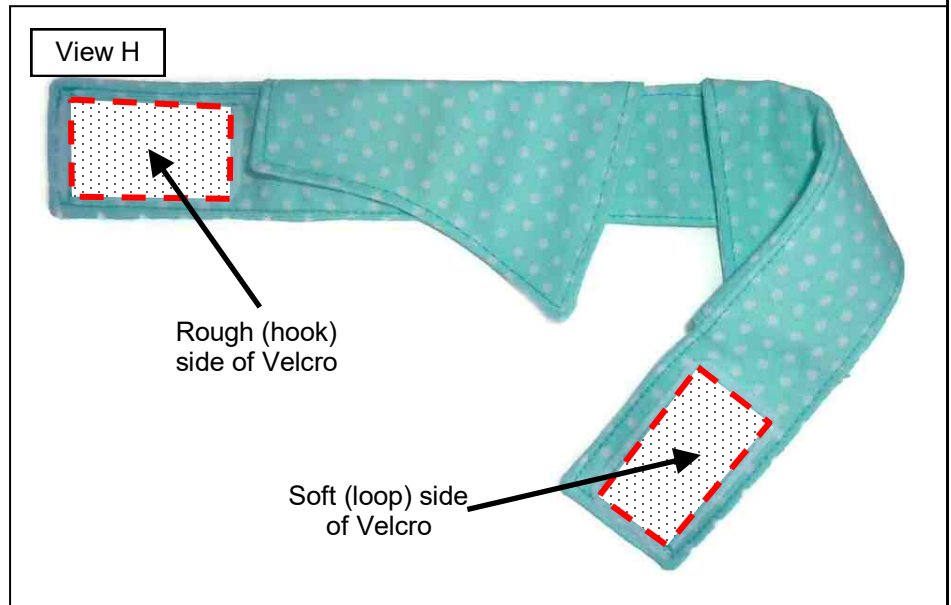

16) RIGHT sides together sew lower edges of Tie and Tie Lining. (View I)

17) Trim point of tie. (View I)

18) Open Tie and fold Lining to backside of Tie. Press. (View J)

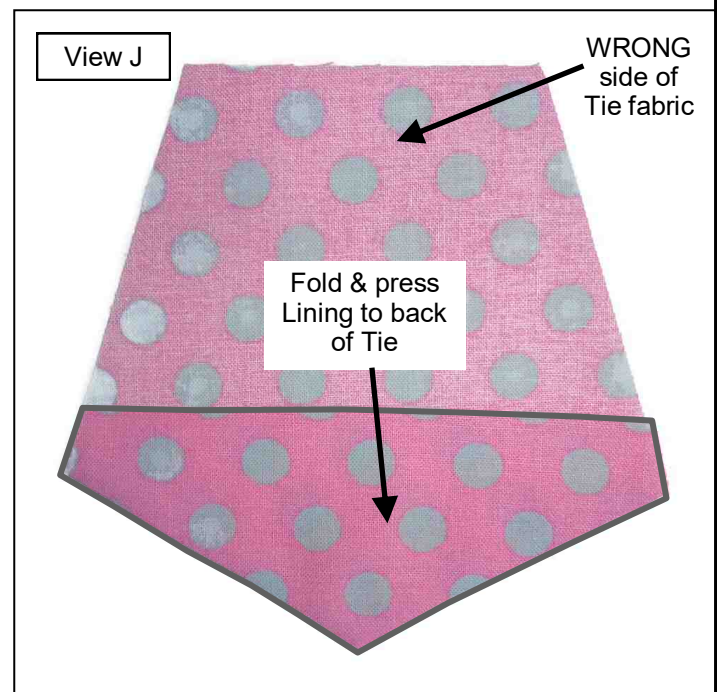

- 19)RIGHT sides together fold Tie in half vertically and sew edges. (View K)
- 20)Turn Tie right side out. Fold & press Tie centering seam as shown. (View L)

View K

Fold Tie in half and sew edges together



View L

Press Tie centering the seam



- 21)RIGHT sides together fold Tie Knot in half lengthwise and sew edges. (View M)

View M

Sew Knot edges

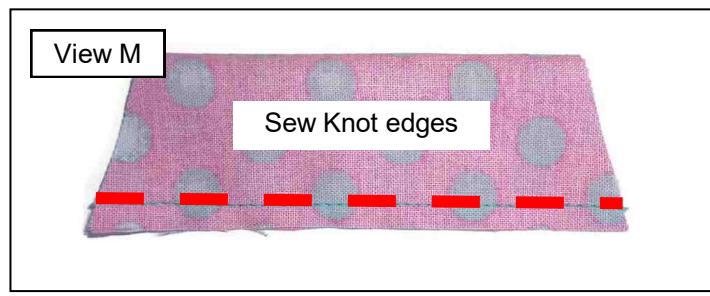

View N

Turn Knot right side out and press

- 22)Turn Knot right side out and press. (View N)





23) Pin Knot to RIGHT side of Tie matching upper edges. Seam side of Knot should be on the right. (View O)

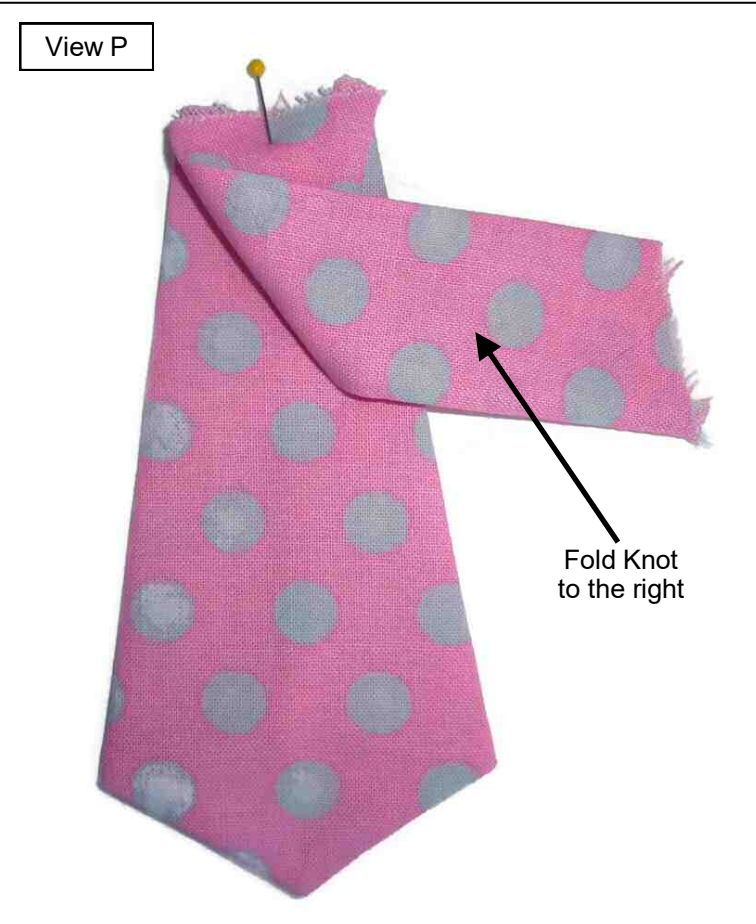
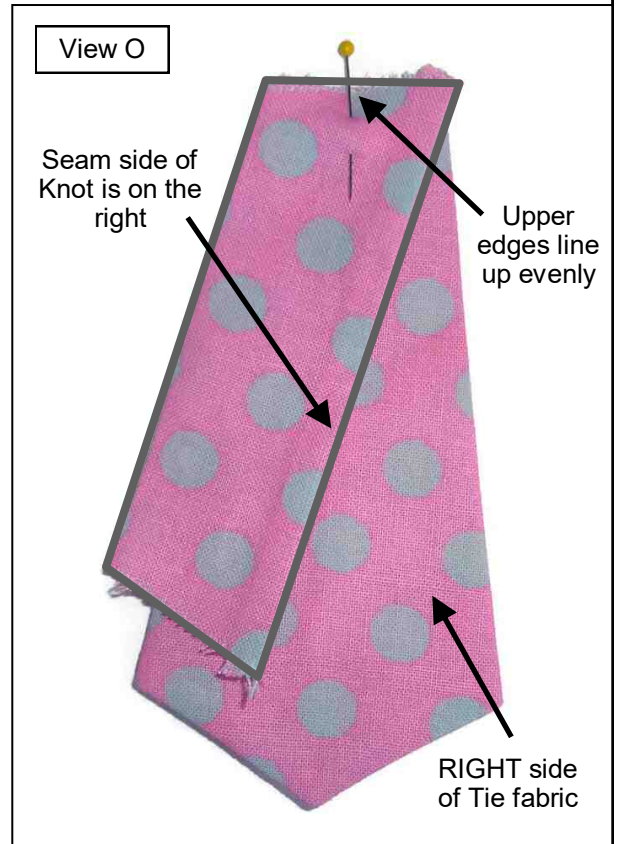

24) Fold Knot to the right as shown. (View P)

25) Form a loop by folding under right side of Knot and matching up raw edge with Tie & left side of Knot. Sew upper edges together. (View Q)

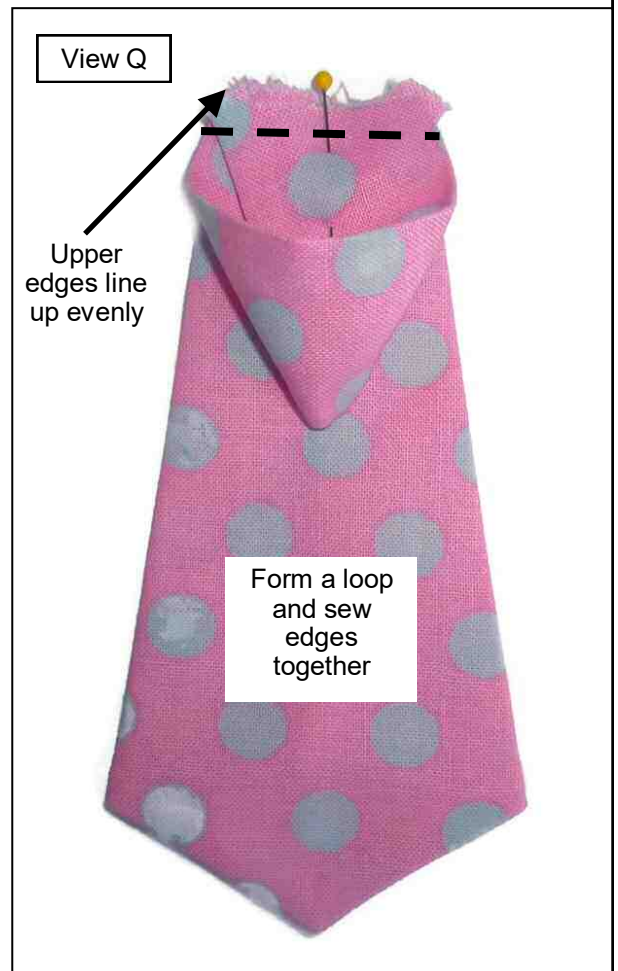

26) Open Tie as shown. (View R)

27) Pull point of Tie through loop. (View S)

View R



Open Tie

View S



Pull Tie  
through loop

View T



Adjust Tie as  
necessary

28) Adjust Tie as necessary. (View T)

29)View of backside of Tie. (View U)

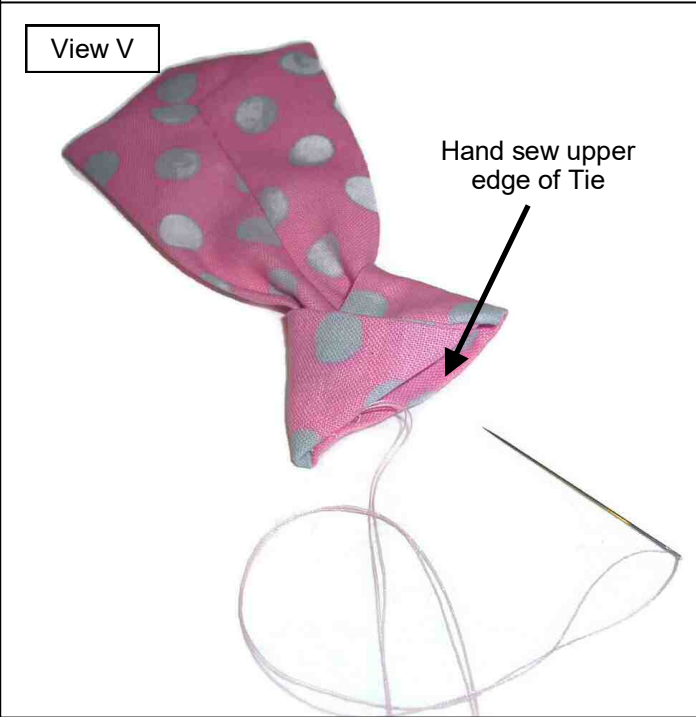

30)Hand sew upper edge of Tie. (View V)

31)Attach sew on snaps to front of Neckband and backside of Tie. (View W)

Note: the use of snaps makes the tie interchangeable, easier to wash and keeps the points of the Tie lying nicely under the Collar.

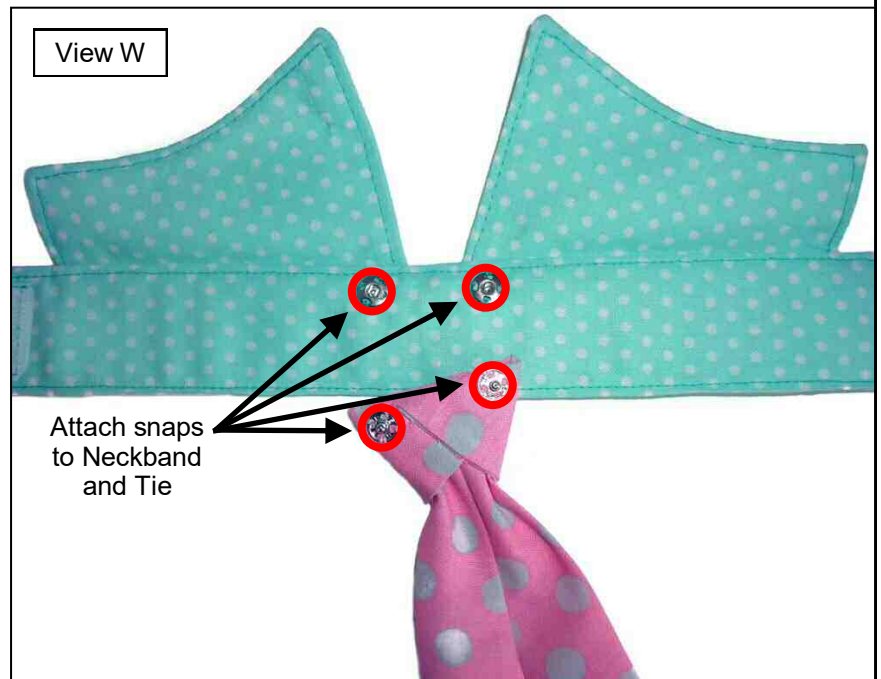



32) Following manufacturer's instructions apply interfacing to each Cuff.

33) RIGHT sides together sew all four sides of Cuffs leaving open between notches. (View X)

View X

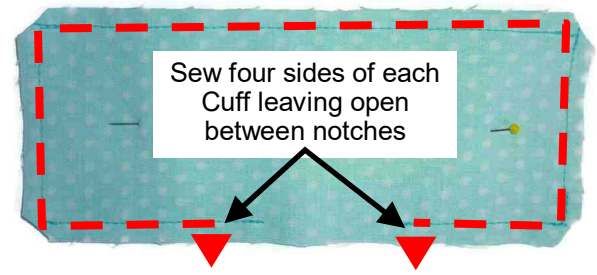

34) Turn Cuffs right side out and press. Fold and press Cuff hems on both sides of opening. (View Y)

View Y

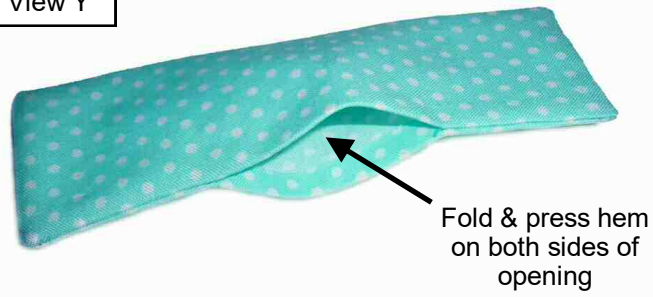

View Z



35) Topstitch Cuffs catching openings. (View Z)

36) Sew Velcro to Cuffs as shown. Both pieces of Velcro are sewn to the same side of the Cuff. (View AA)

Note: wrap Cuff around your dog's leg for fit and adjust Velcro size as needed.

View AA

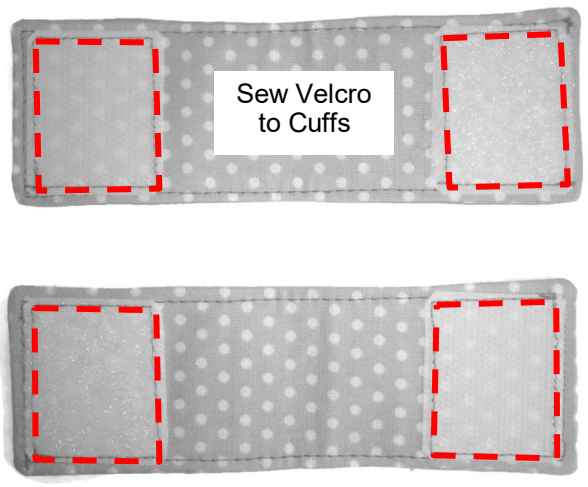

37) Sew or glue buttons to each Cuff. (View BB)

Note: either fabric glue or hot glue works well.

View BB



**SEWING INSTRUCTIONS**

- 1) Follow instructions for Collar A Steps 1 through 15.
- 2) RIGHT sides together sew all four sides of Bow. (View A)
- 3) Trim corners. (View A)

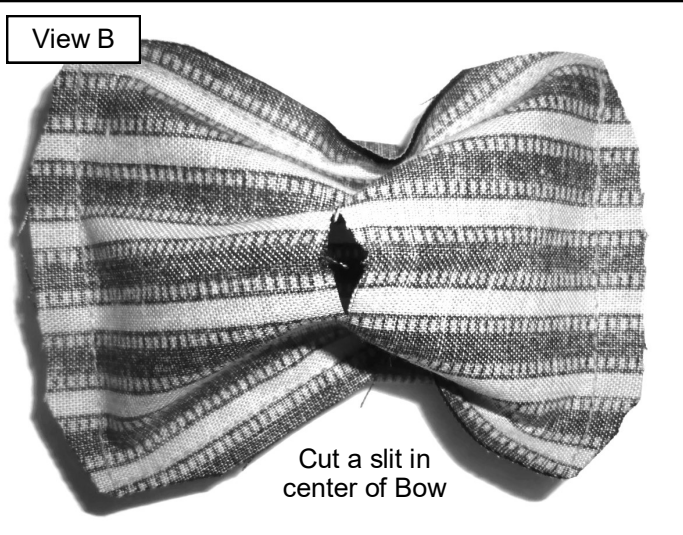
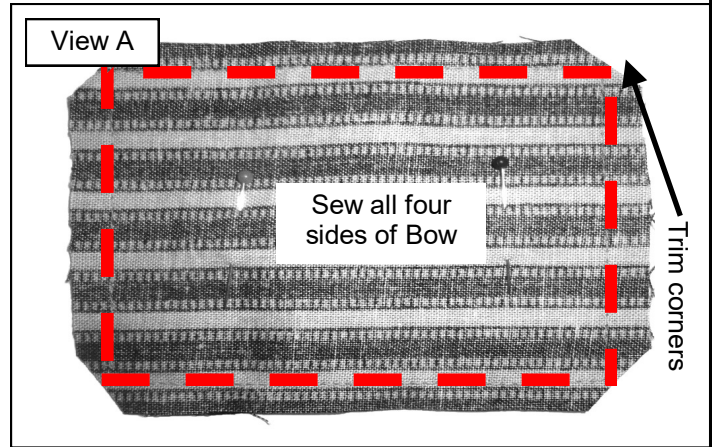

- 4) "Pucker" one side of Bow and cut a vertical slit in the center. (View B)

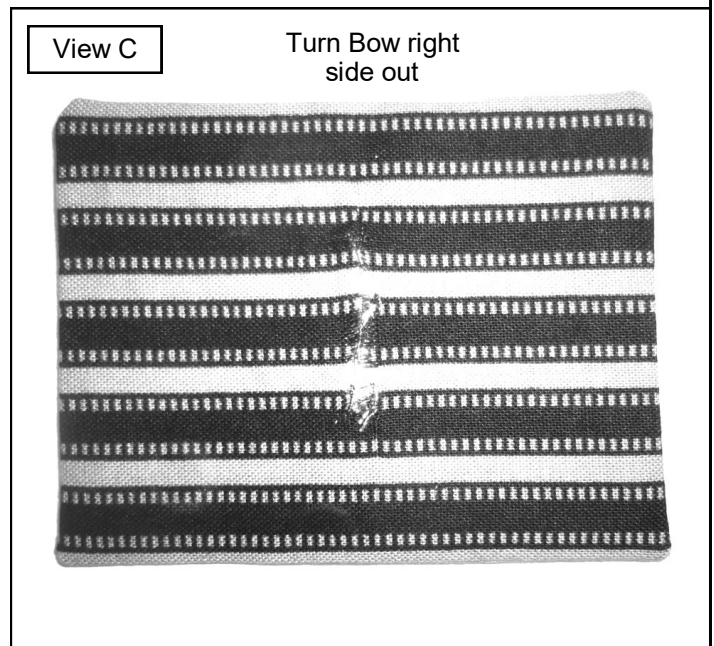

- 5) Pull Bow right side out through slit & press. (View C)  
Note: Use Fray Check on slit opening.

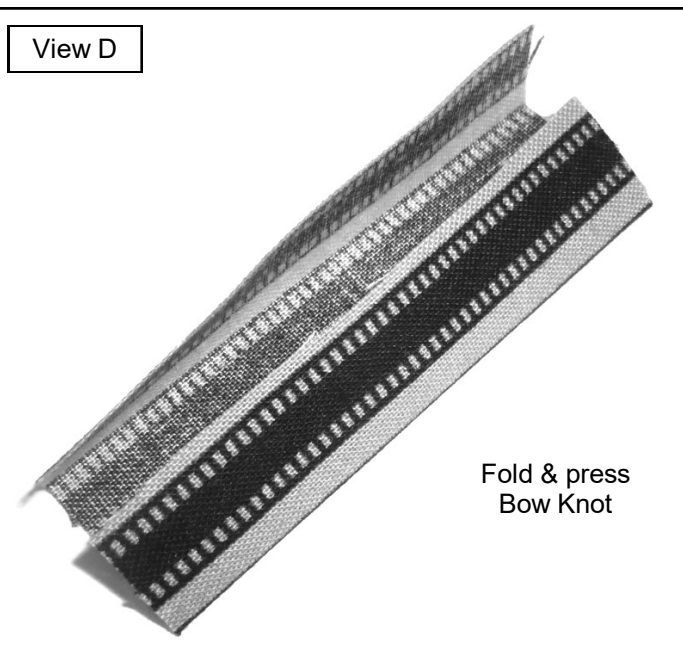

- 6) Fold & press Bow Knot per pattern instructions. (View D)



- 7) Pinch center of Bow together and wrap with Knot. (View E)  
Note: trim length of Knot as needed.
- 8) Sew or glue ends of Knot together. (View E)  
Note: either fabric glue or hot glue works well.

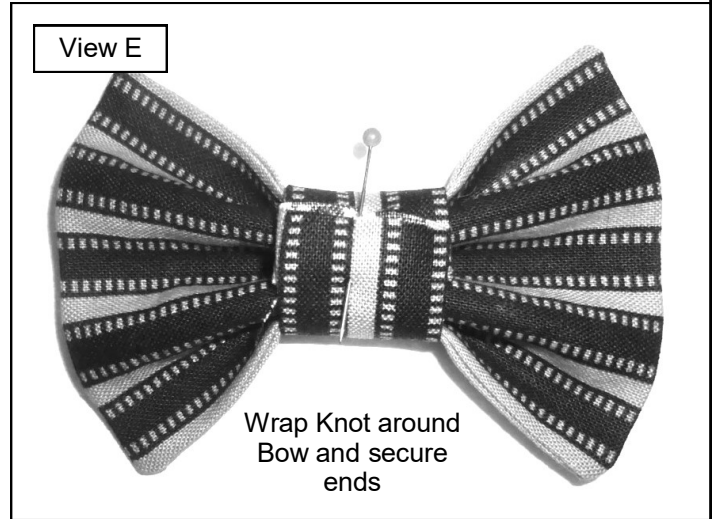

- 9) Sew or glue a snap to center of Neckband and back of Bow. (View F)

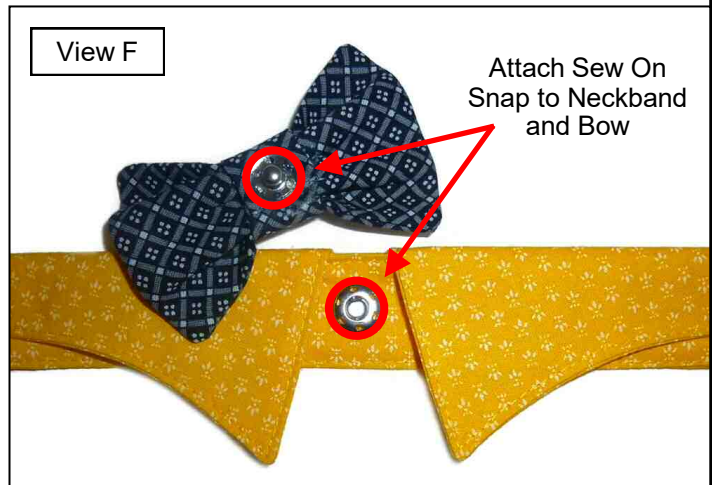

- 10) Optional: attach chain or decorative jewelry to Neckband. (View G)
- 11) Follow instructions for Collar A Steps 32 through 36 to make Cuffs.
- 12) Photo of finished Collar B with Bow, Cuffs & jewelry. (View H)



## PATTERN PIECES

- 1) SHIRT COLLAR A&B NECKBAND
- 2) SHIRT COLLAR A&B COLLAR
- 3) SHIRT COLLAR A TIE
- 4) SHIRT COLLAR A TIE LINING
- 5) SHIRT COLLAR A TIE KNOT
- 6) SHIRT COLLAR B BOW
- 7) SHIRT COLLAR B BOW KNOT
- 8) SHIRT COLLAR CUFF

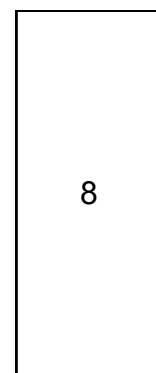
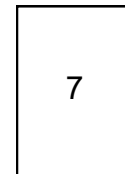
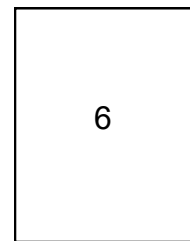
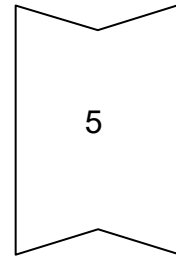
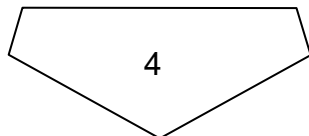
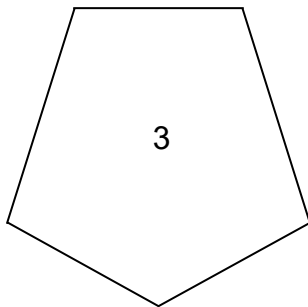
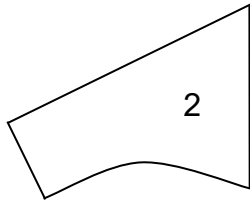
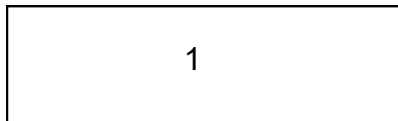

**COLLAR A**

**COLLAR A Fabric A**

USE PIECE 1 2 8

45"fabric

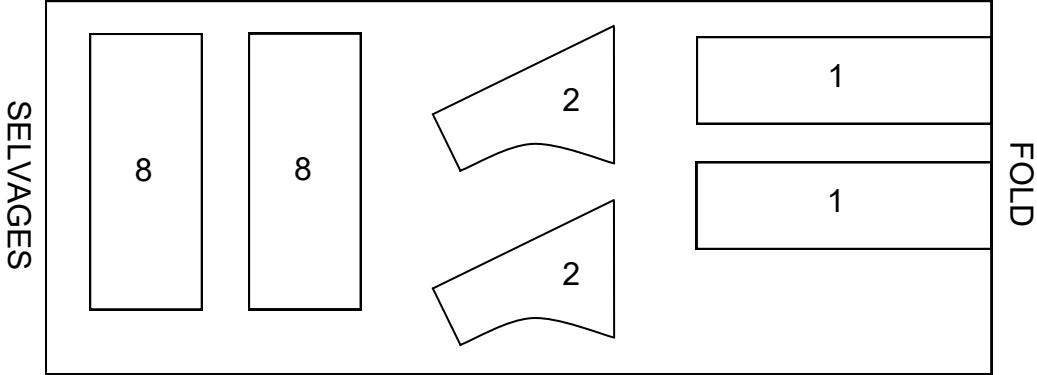

**COLLAR A Tie Fabric**

USE PIECE 3 4 5

45"fabric

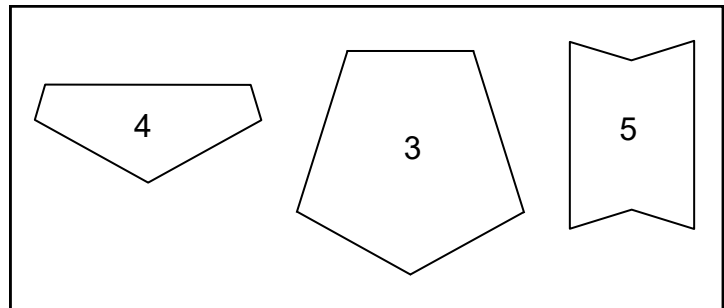

**SINGLE LAYER OF FABRIC**

**COLLAR A Interfacing**

USE PIECE 1 2 8

20"interfacing

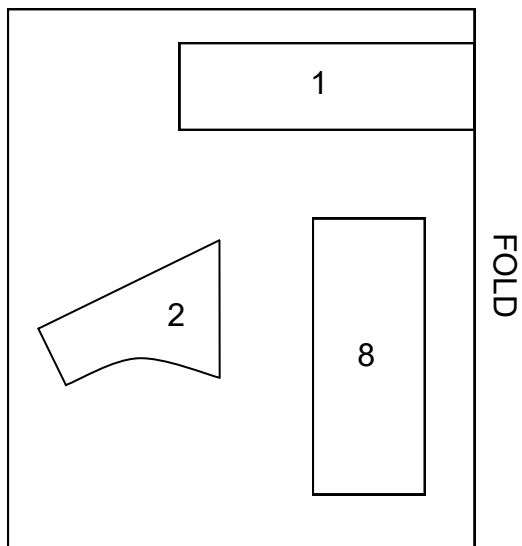

**COLLAR B**

**COLLAR B Fabric A**

USE PIECE 1 2 8

45"fabric

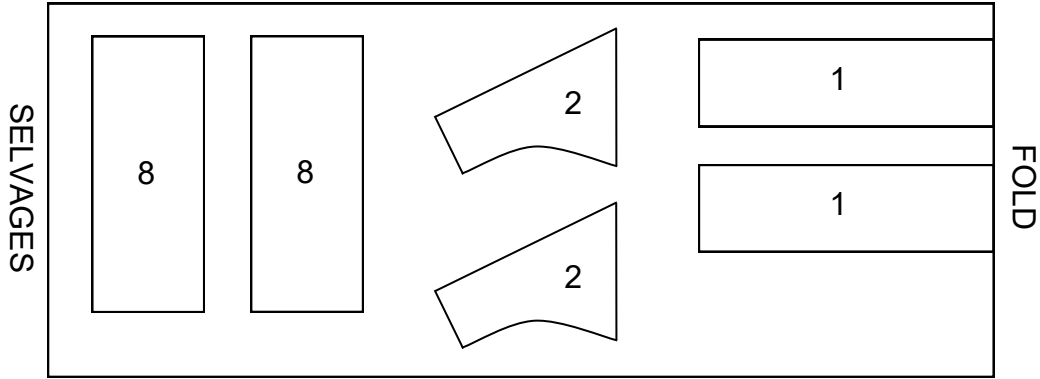

**COLLAR B Bow Fabric**

USE PIECE 6 7

Scrap fabric

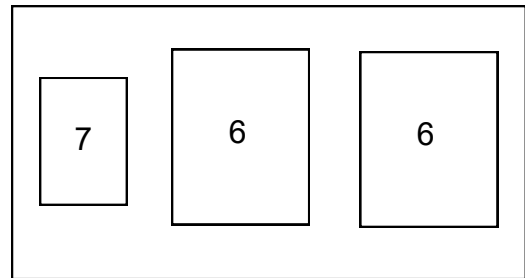

SINGLE LAYER OF FABRIC

**COLLAR B Interfacing**

USE PIECE 1 2 8

20"interfacing

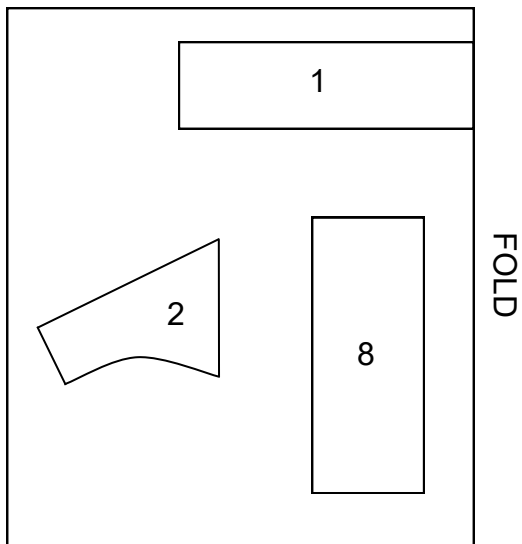

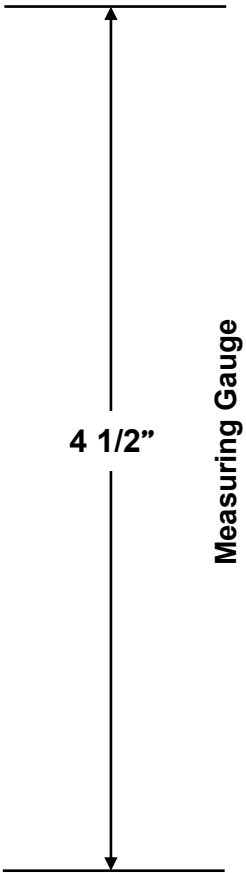
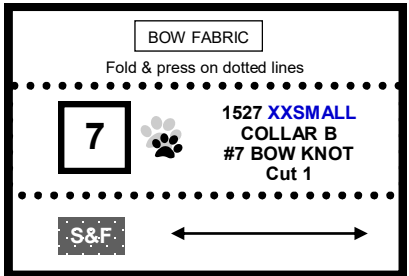
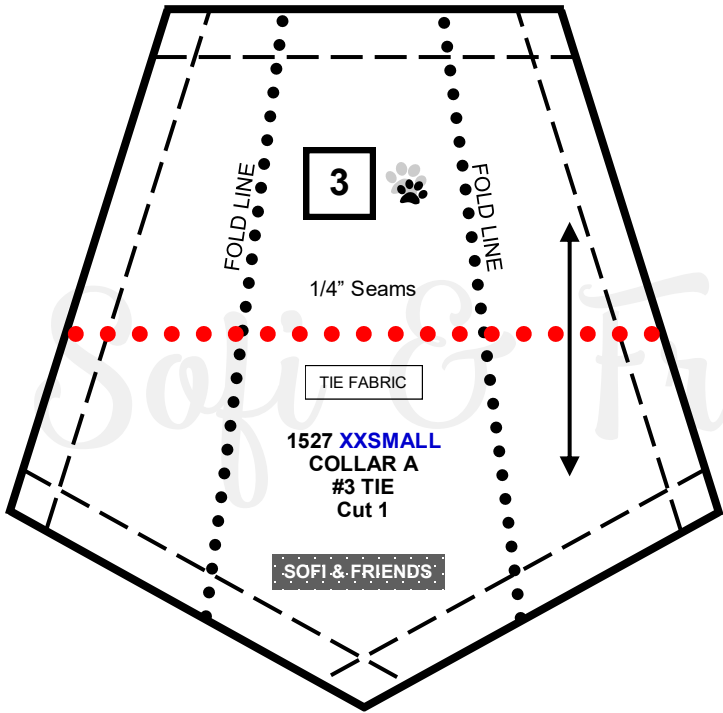
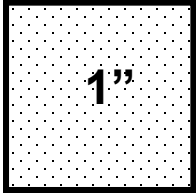

Measuring Gauge

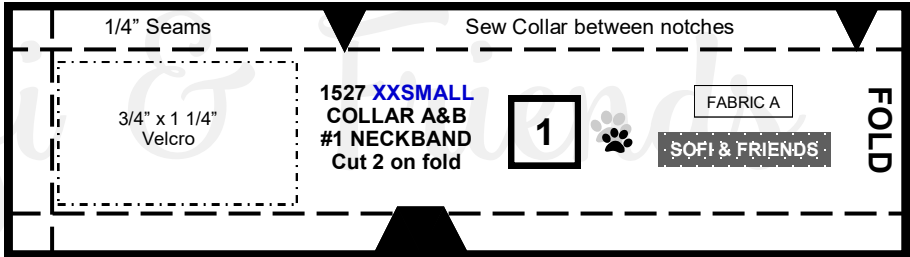
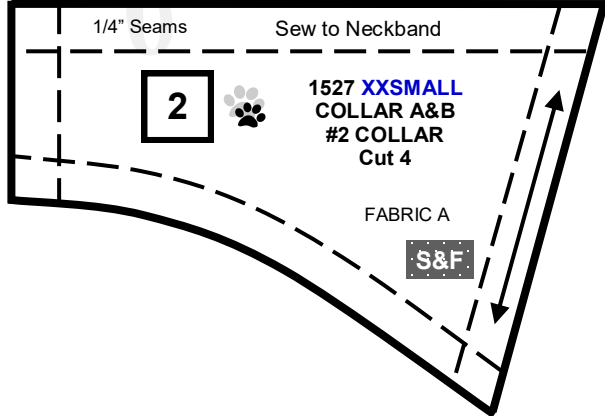



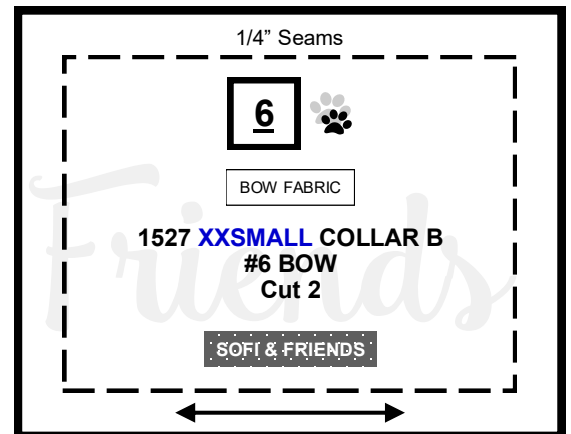
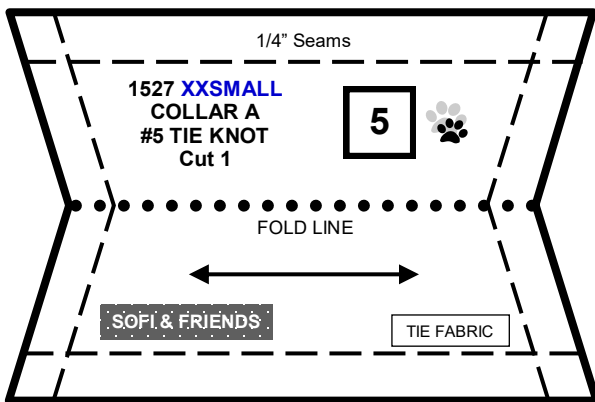
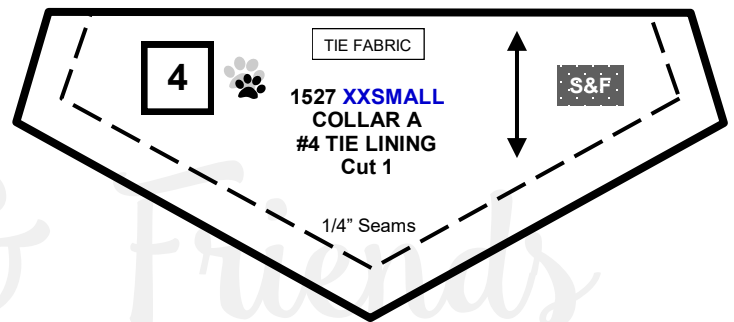
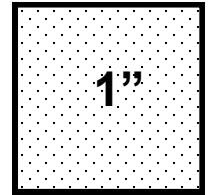
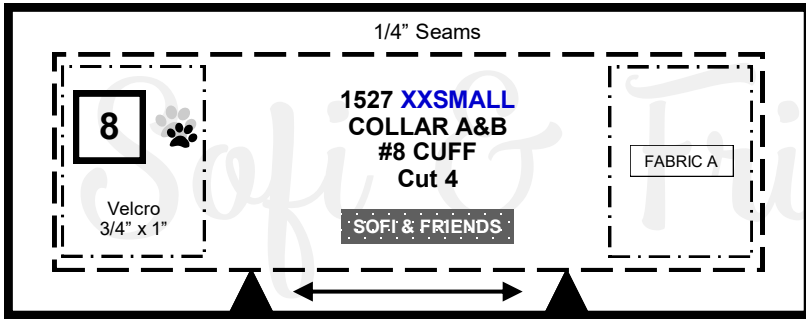

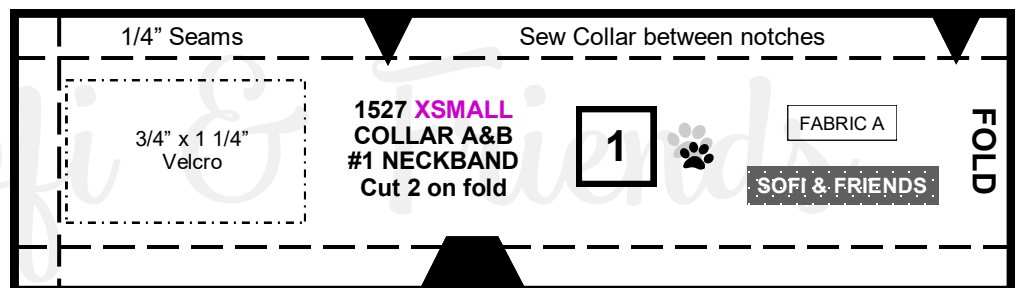
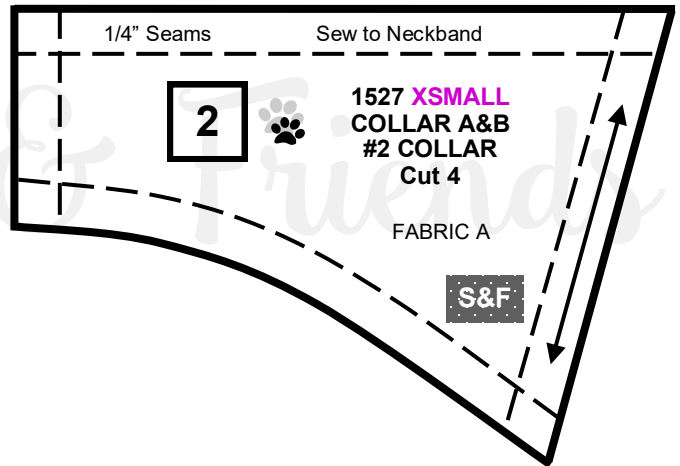
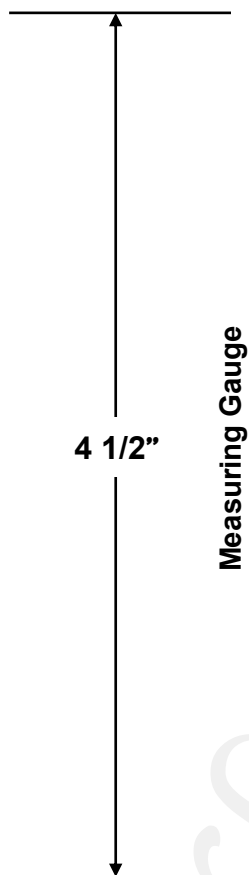
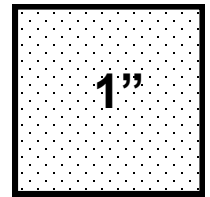
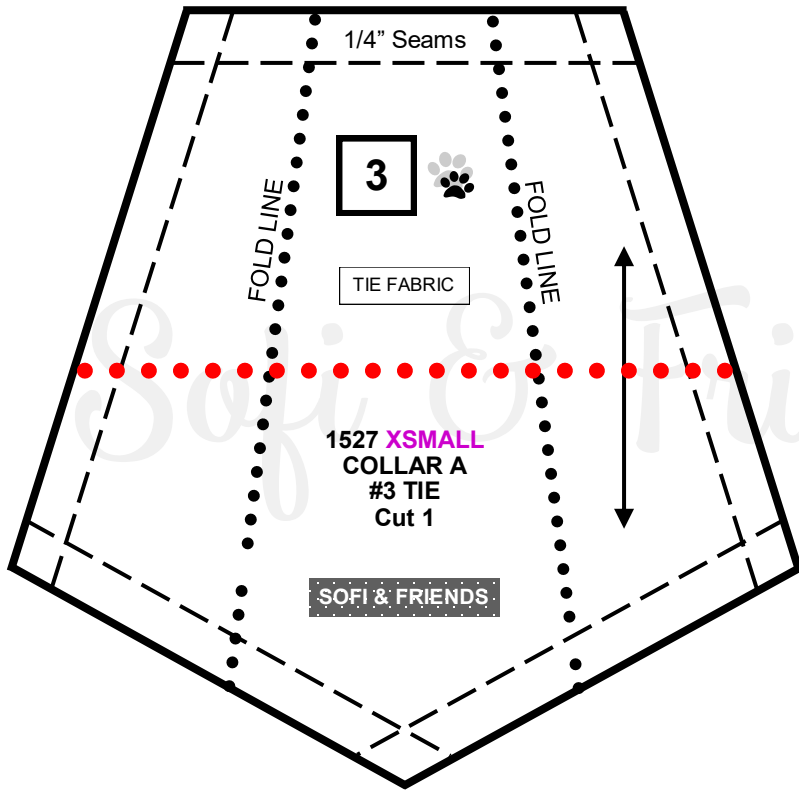

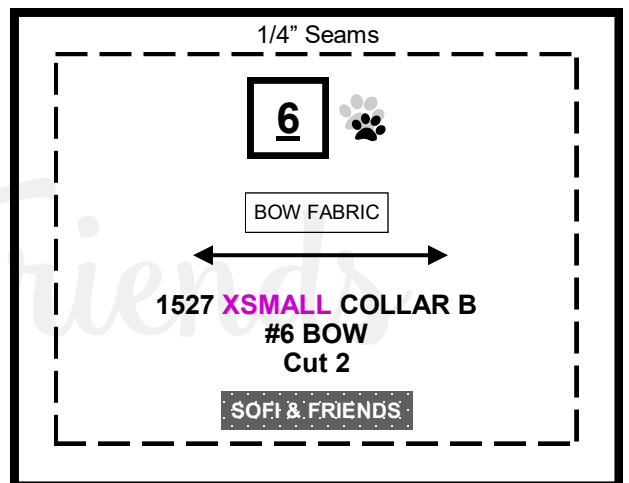
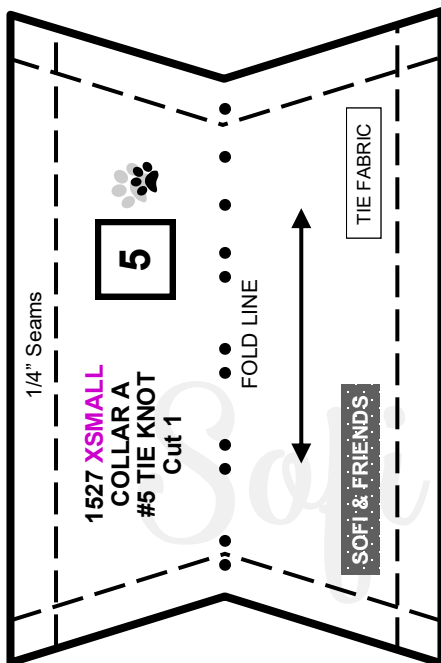
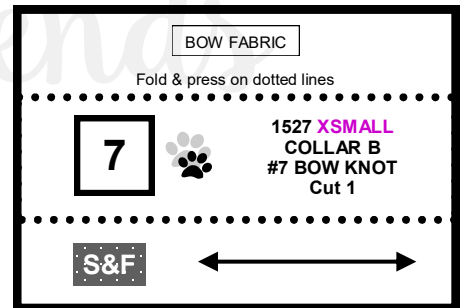
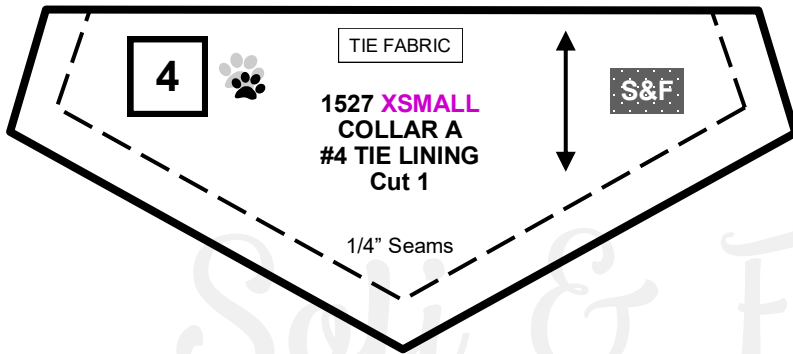
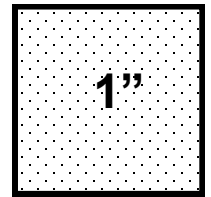
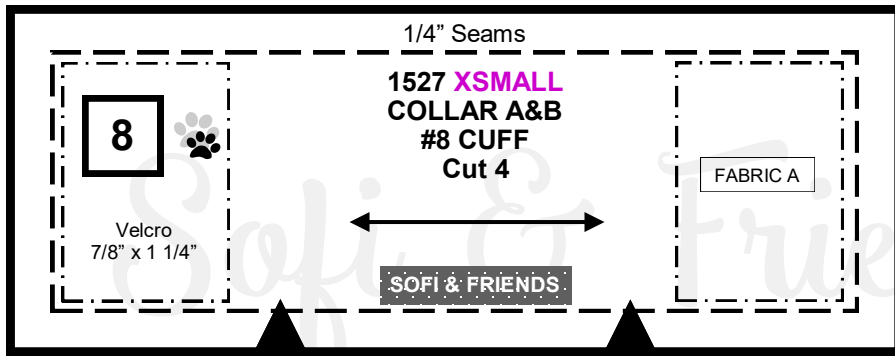

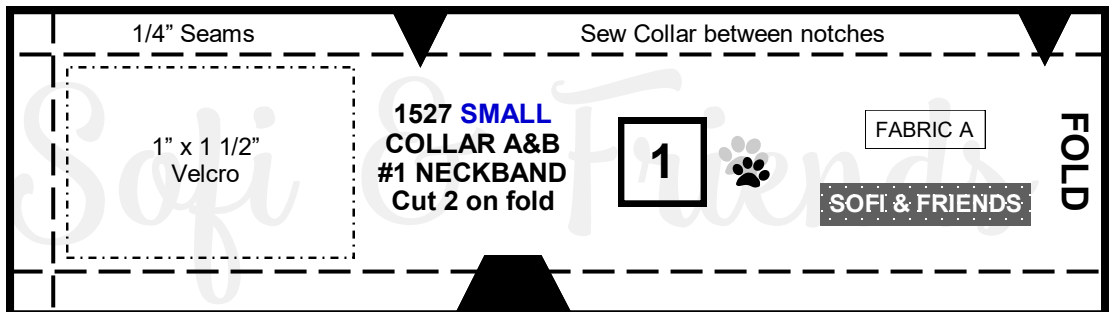
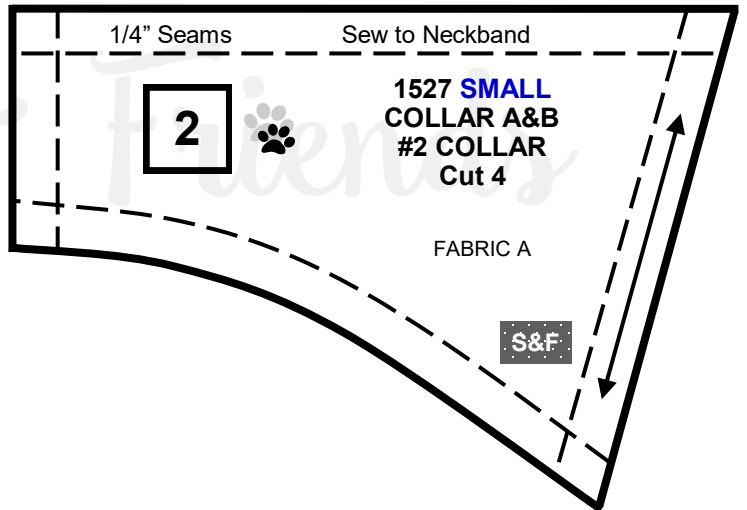
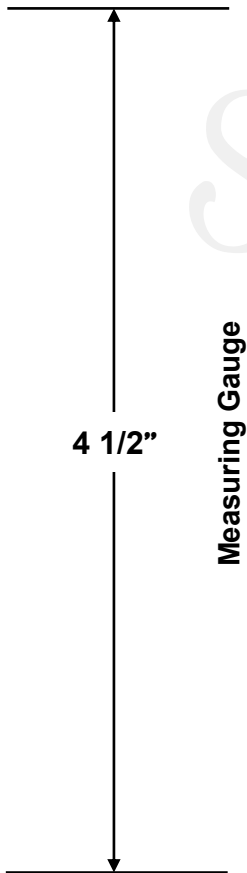
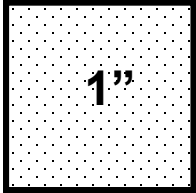
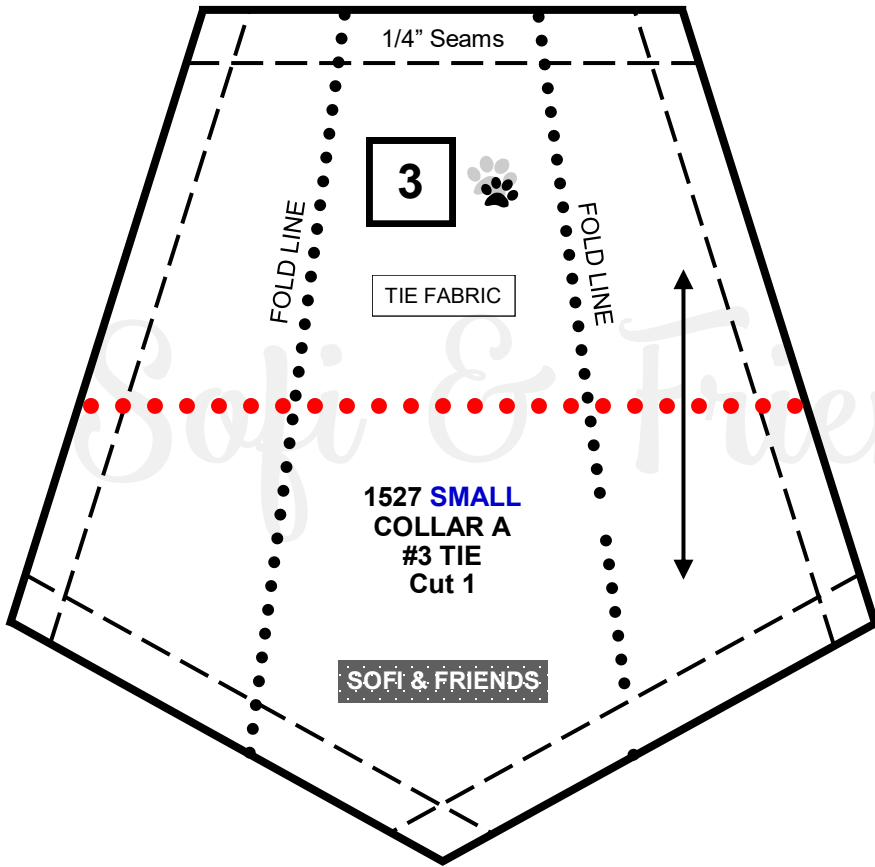

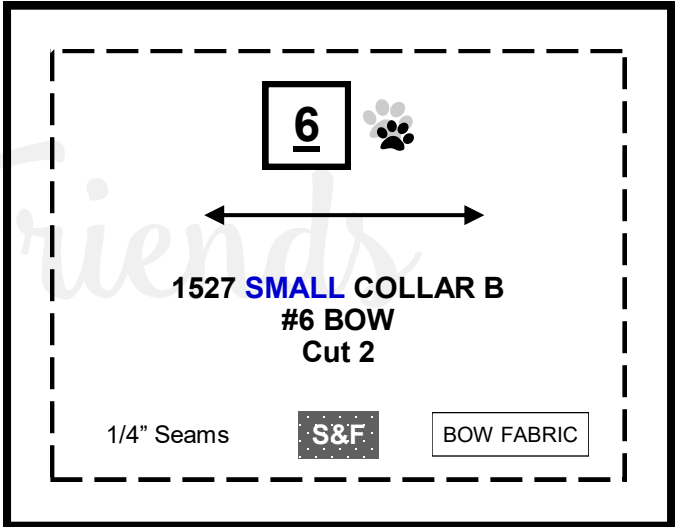
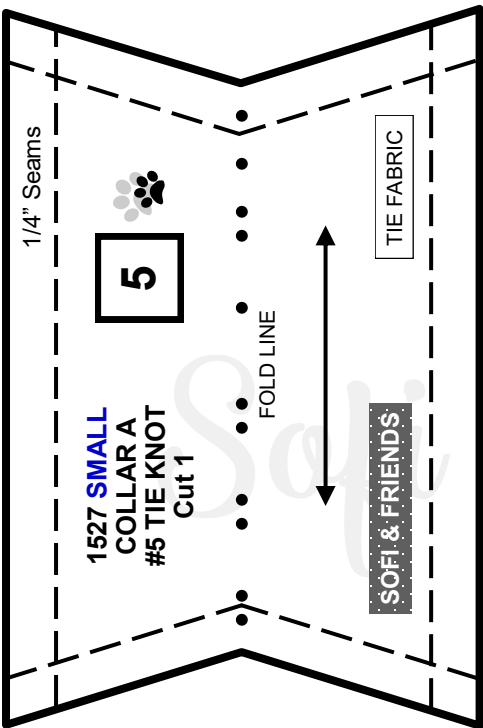
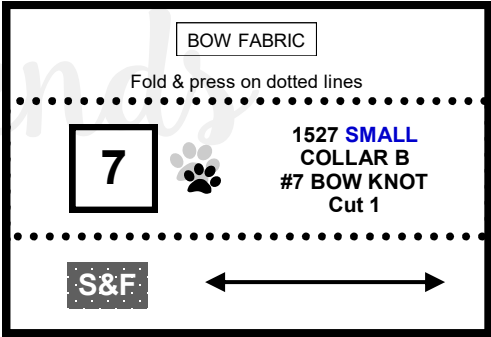
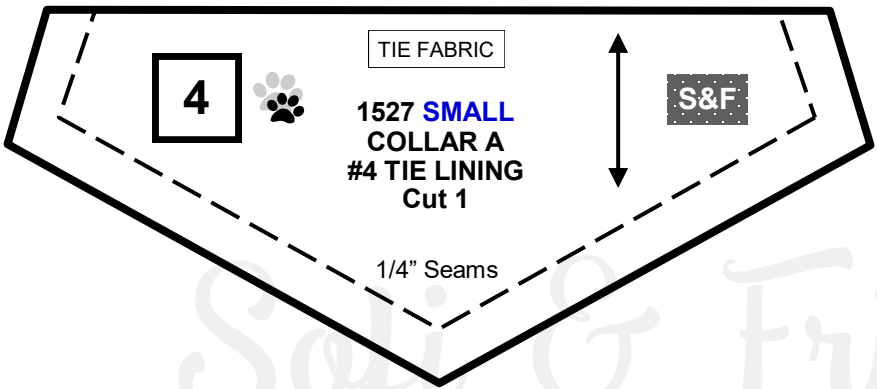
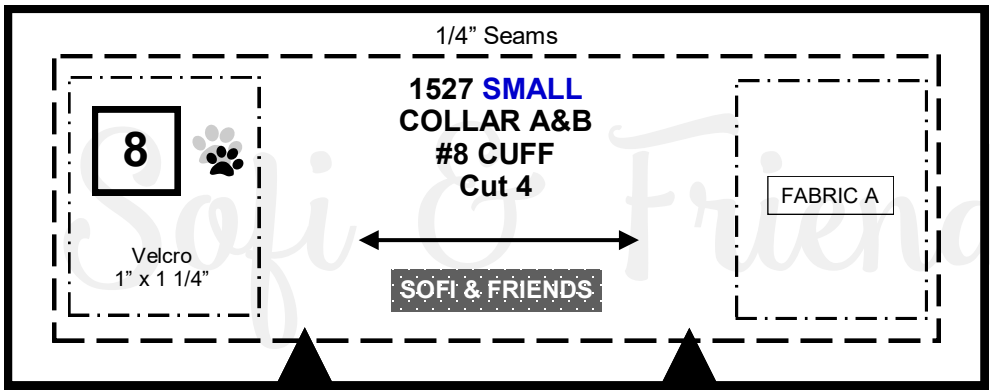
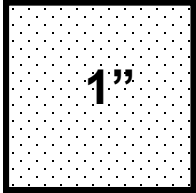



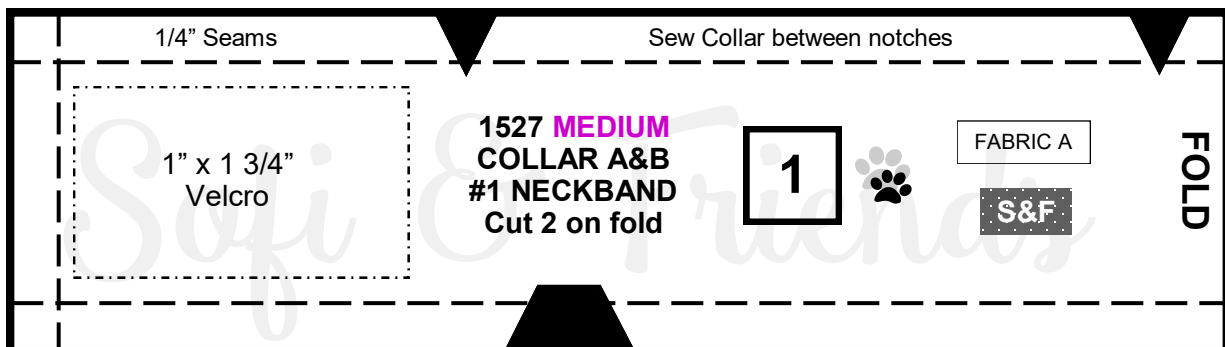
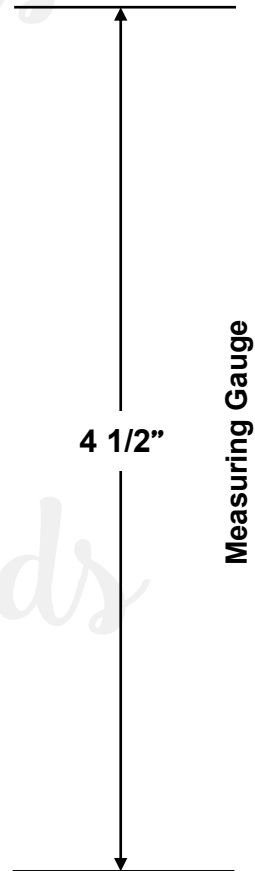
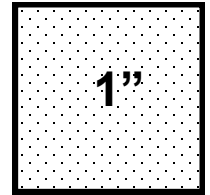
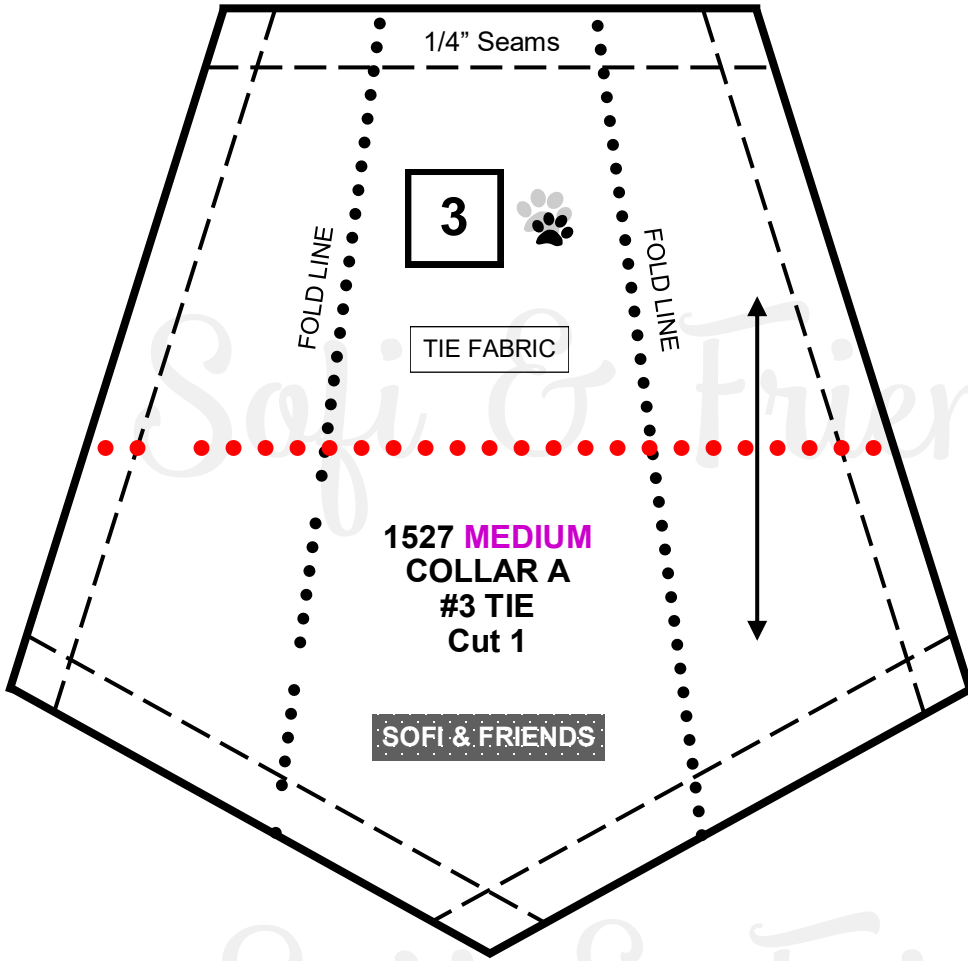

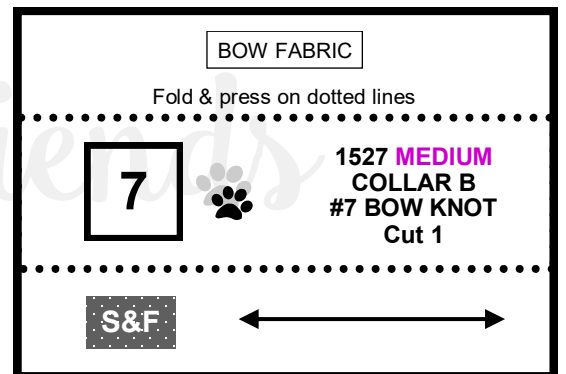
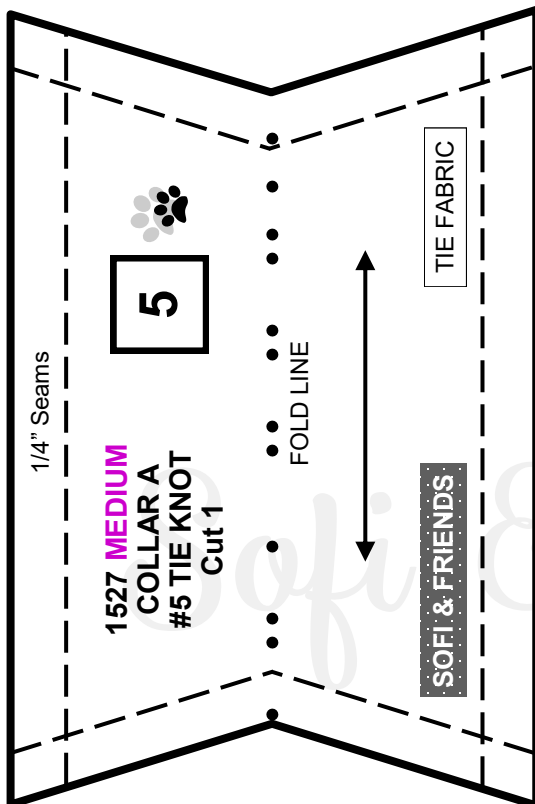
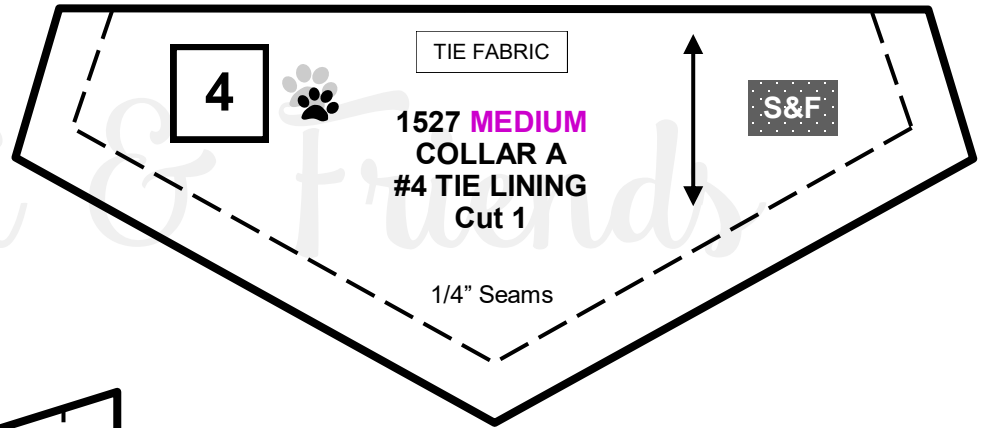
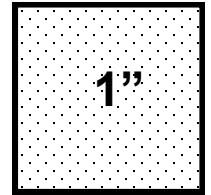
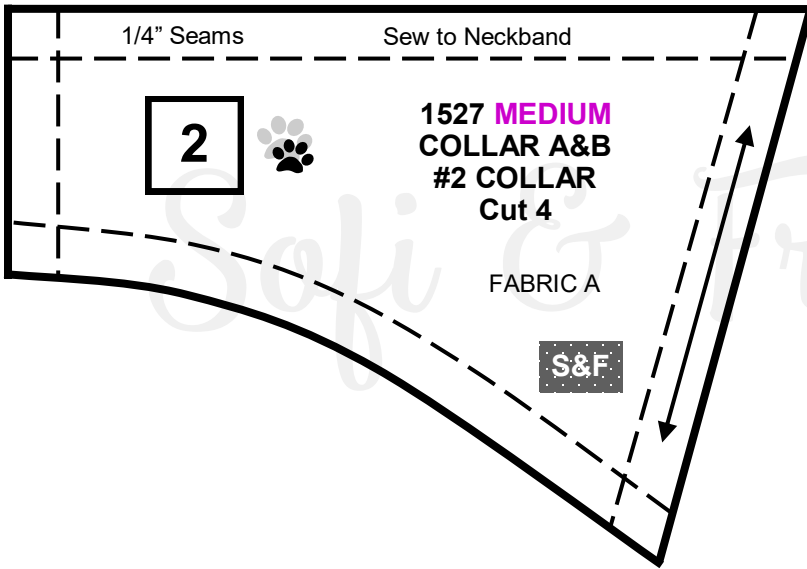

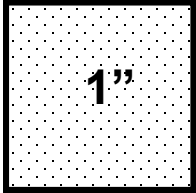

Sofi & Friends

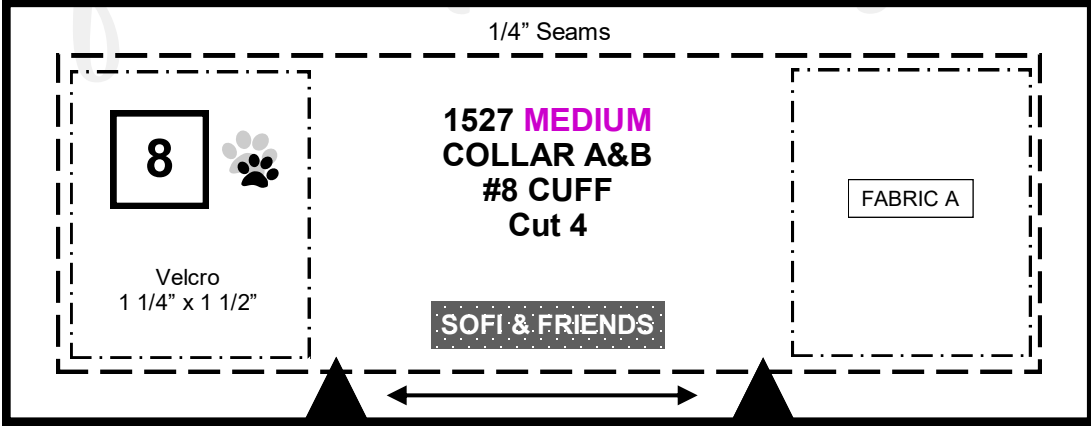

Sofi & Friends

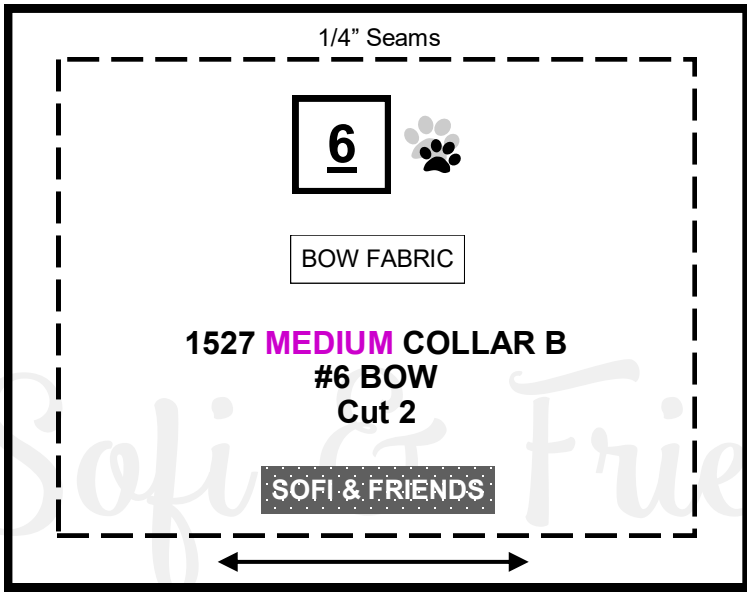

Sofi & Friends

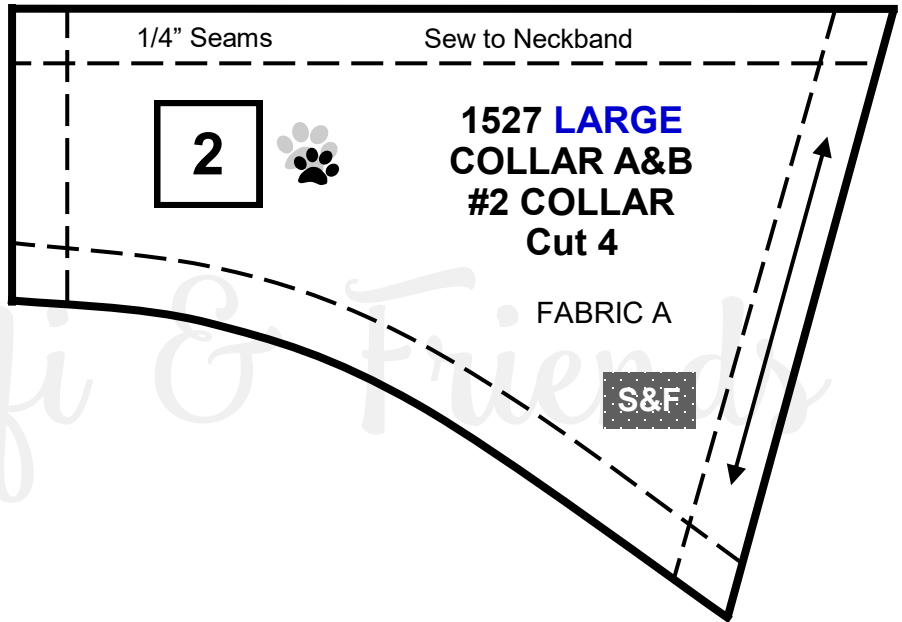
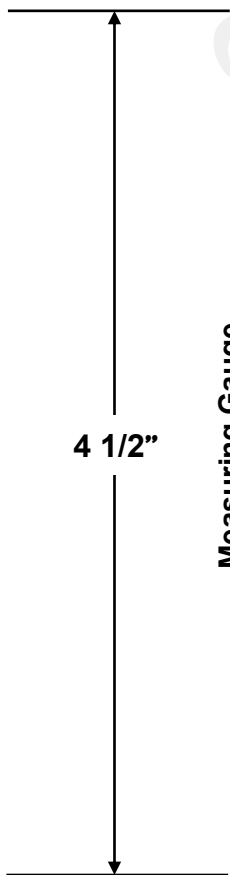
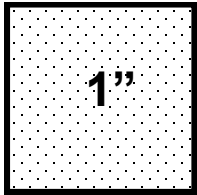
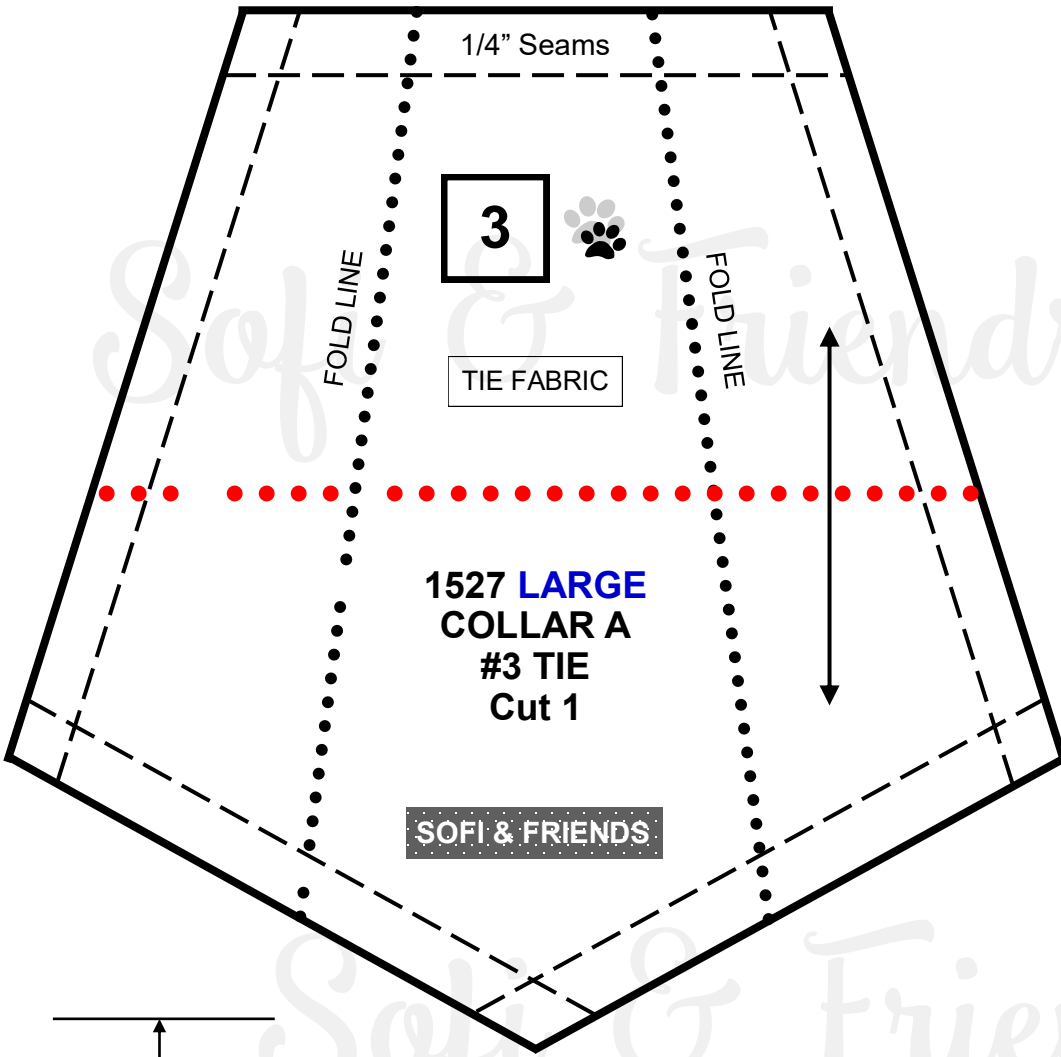

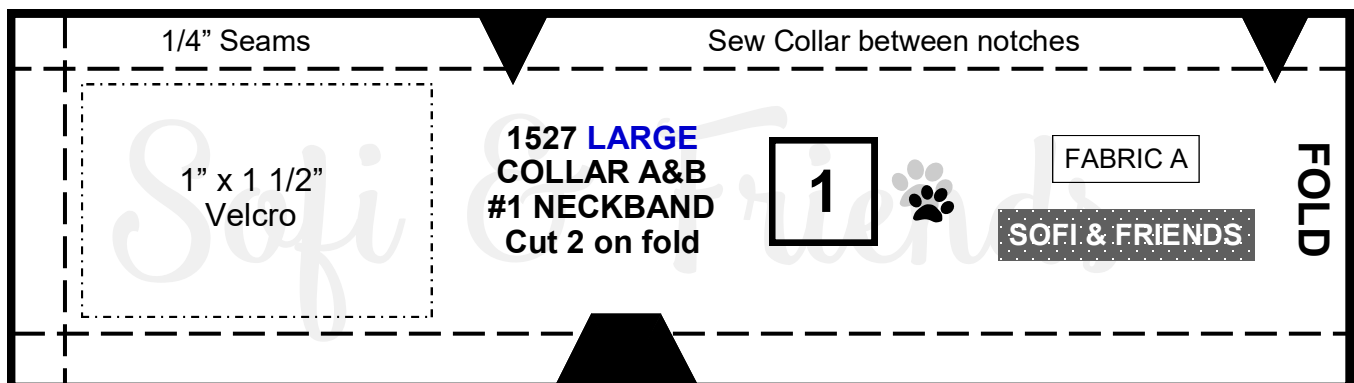
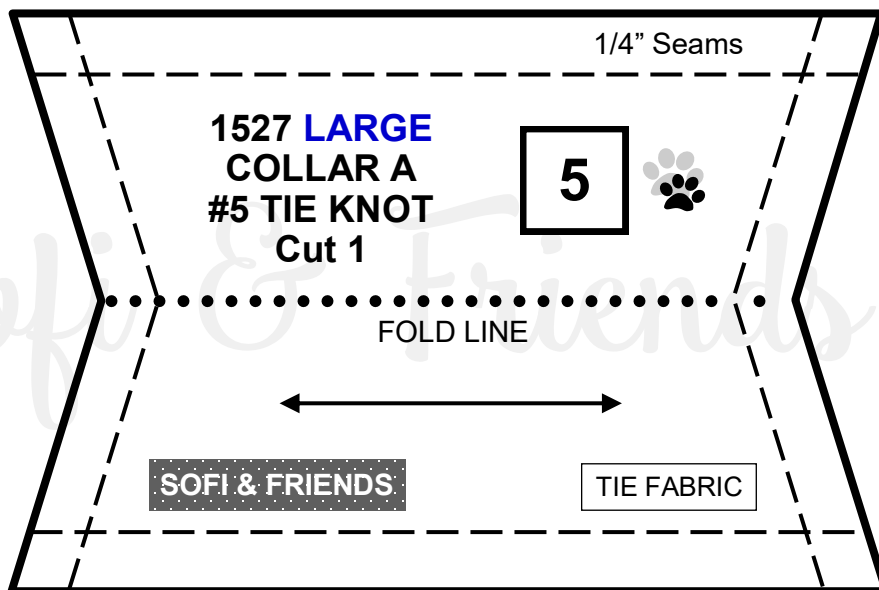
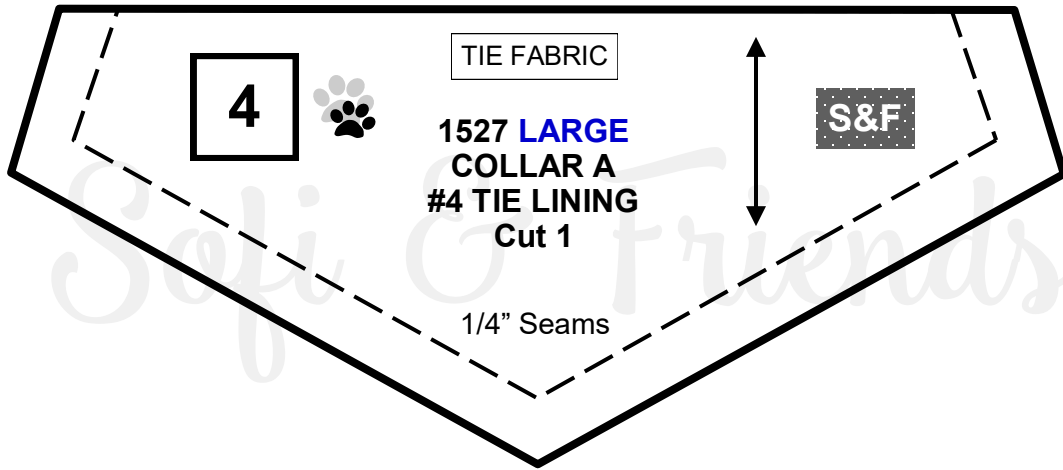



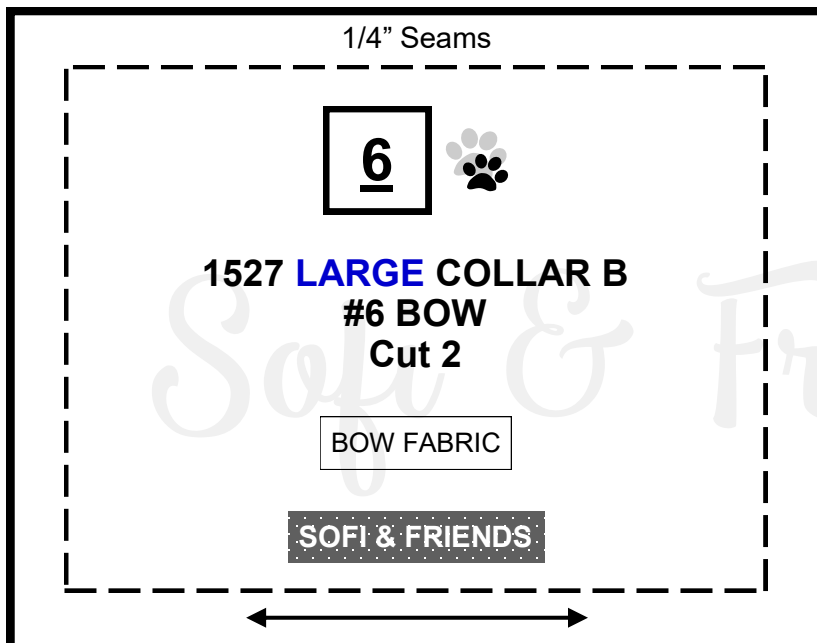
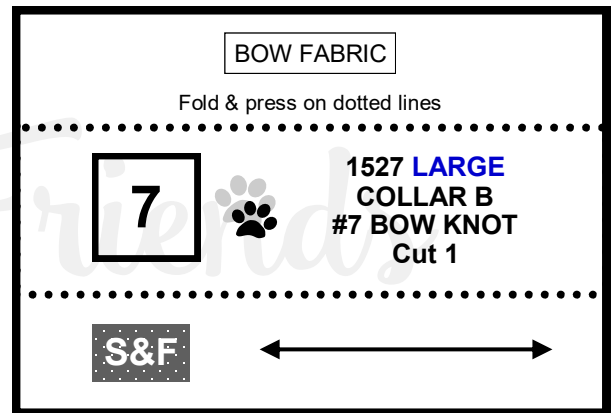
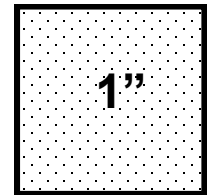
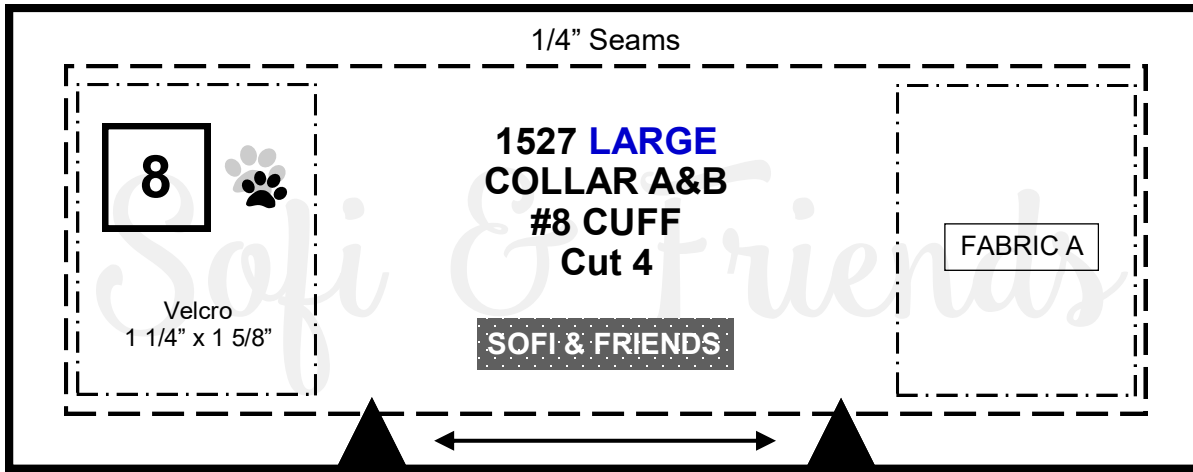

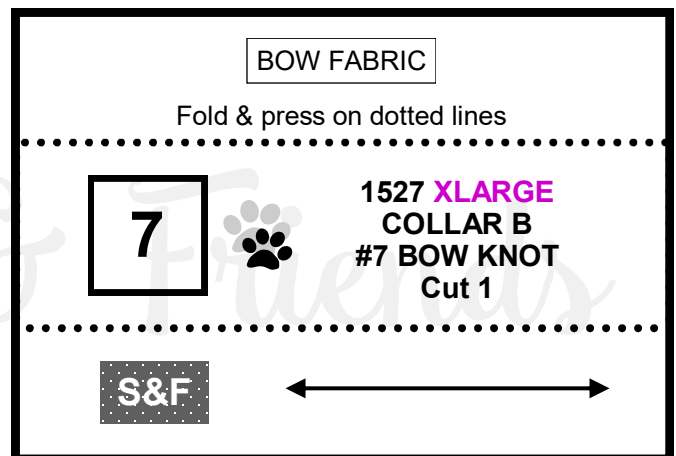
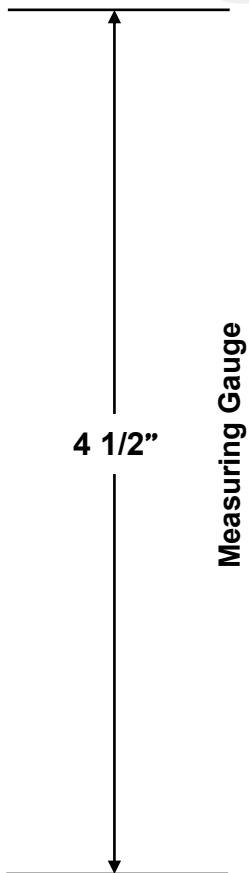
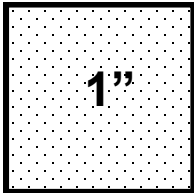
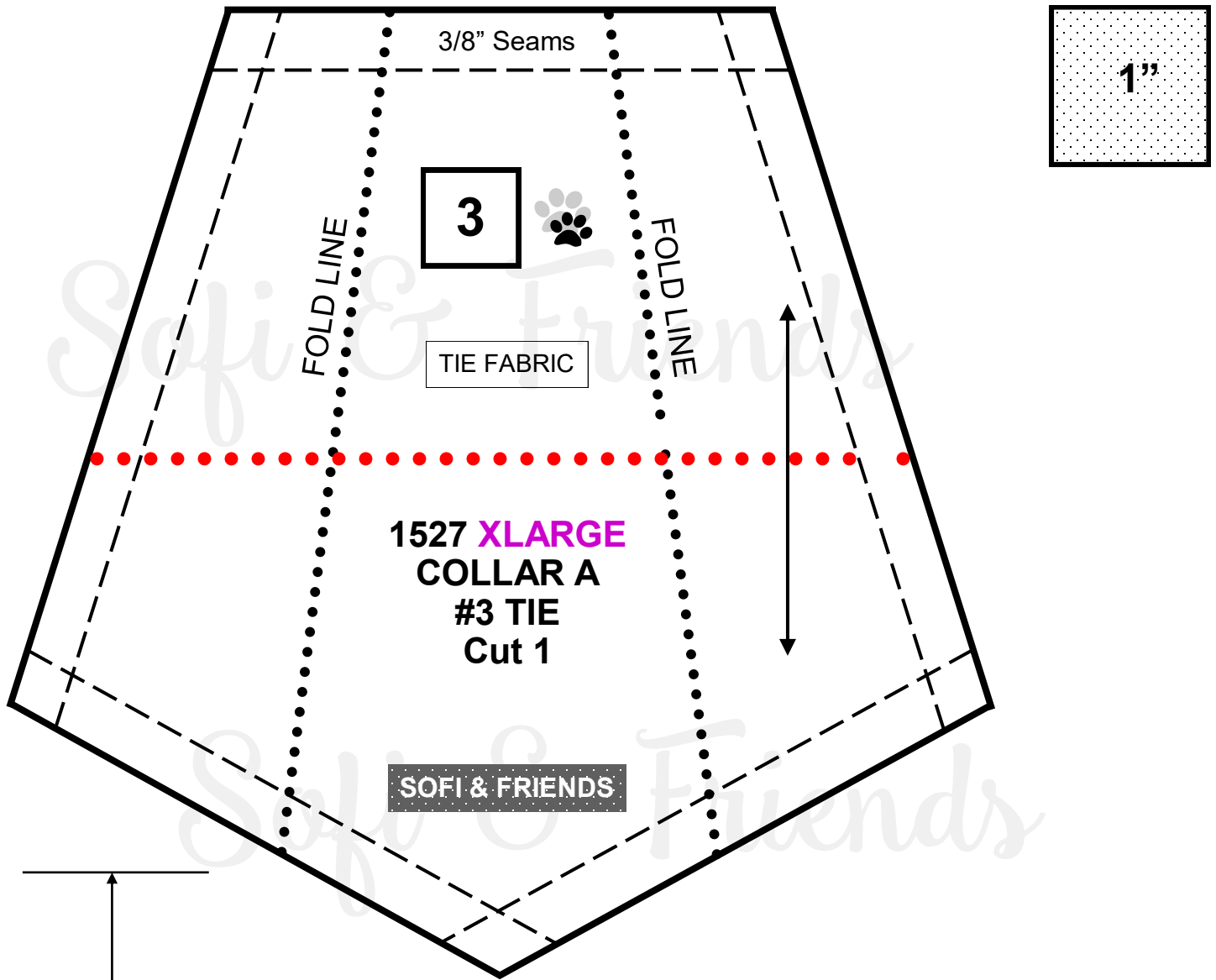

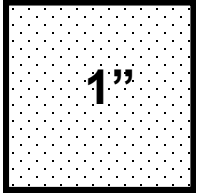
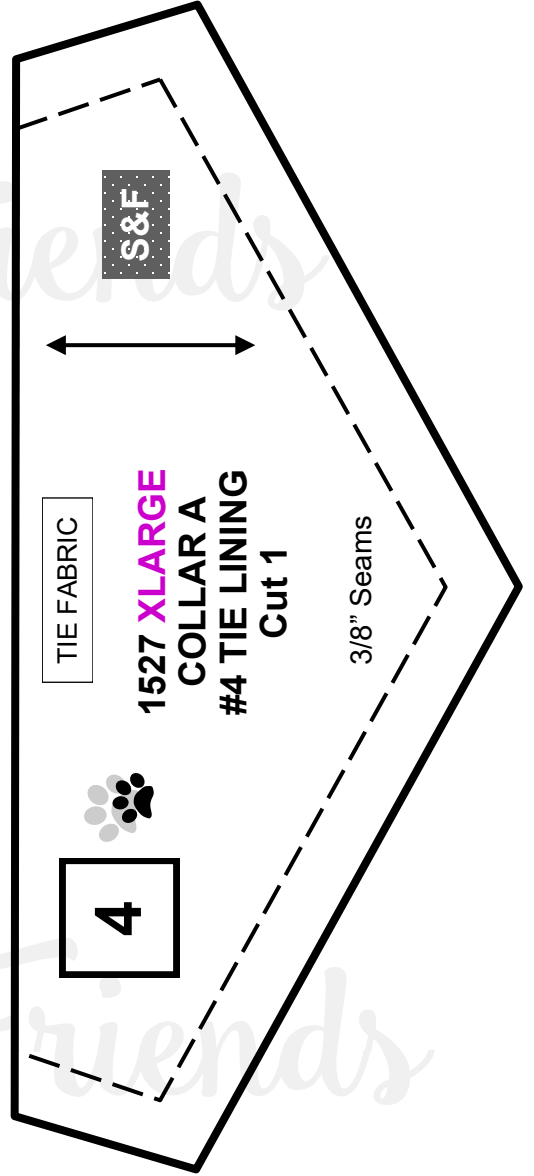
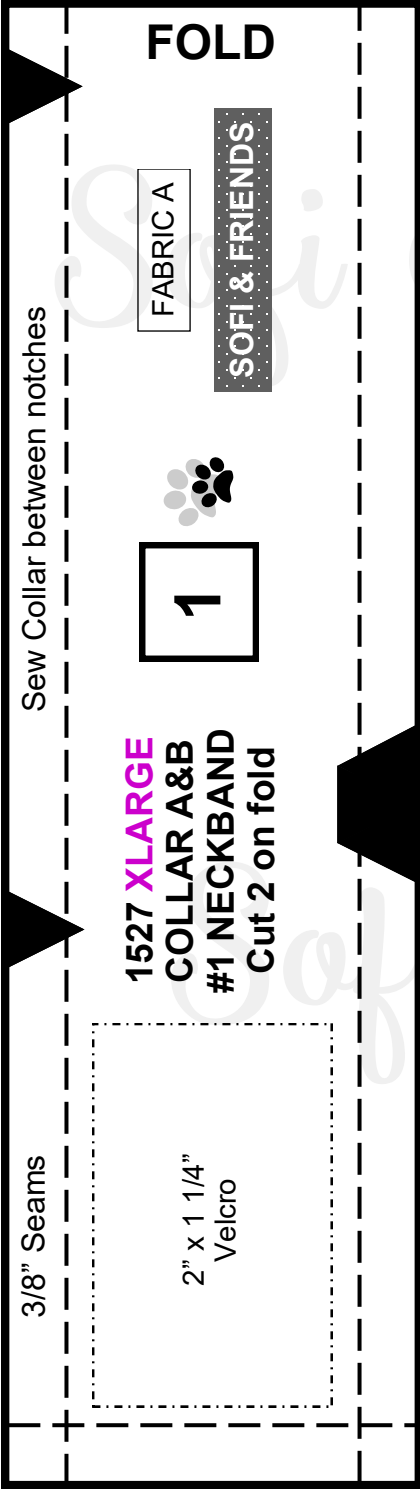

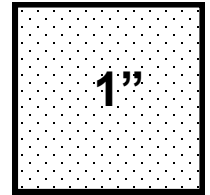
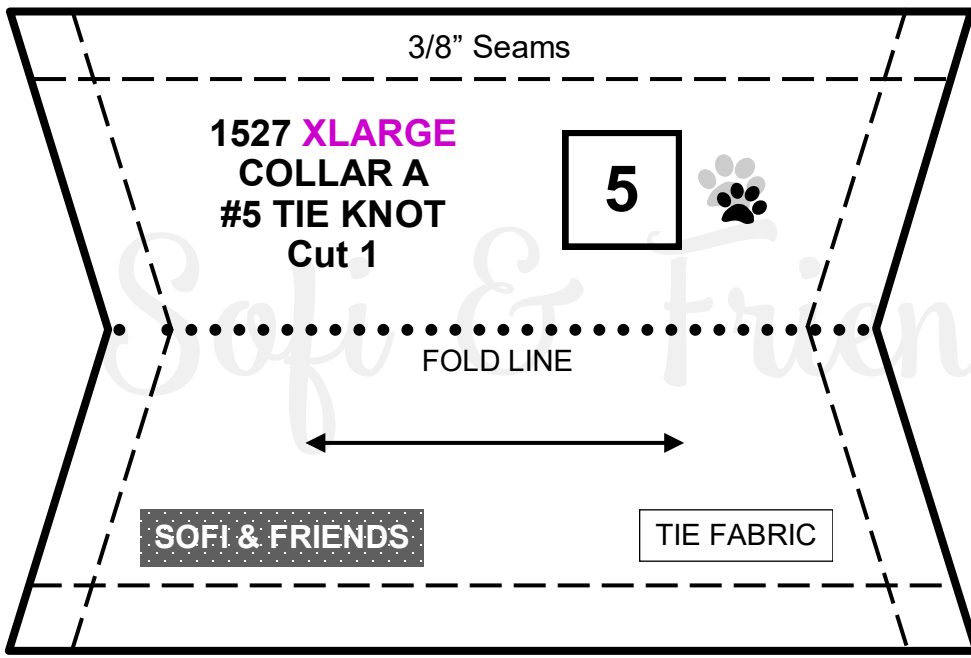

Sofi & Friends

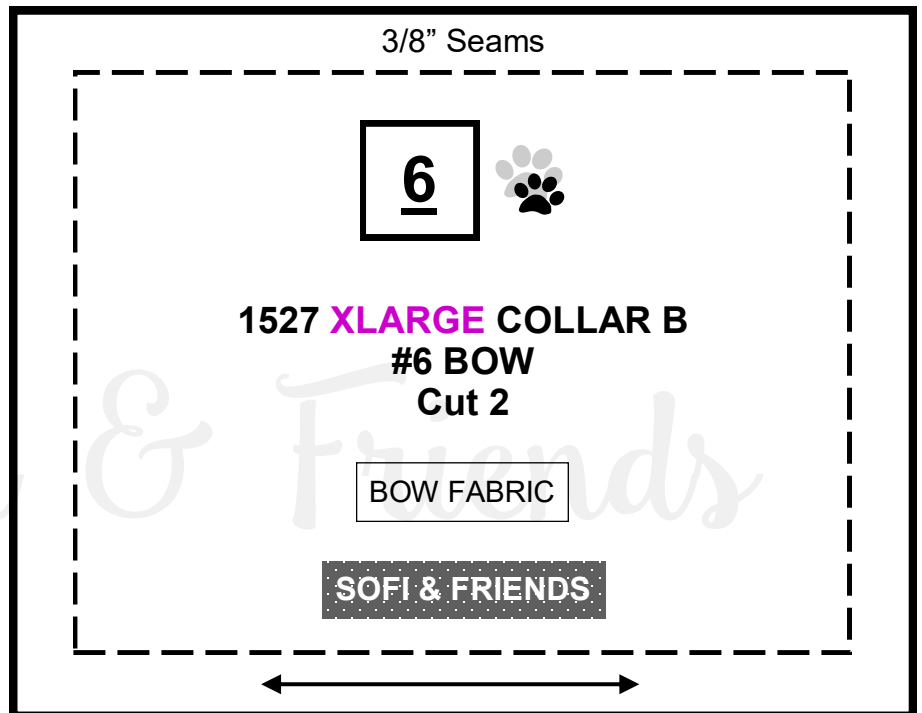

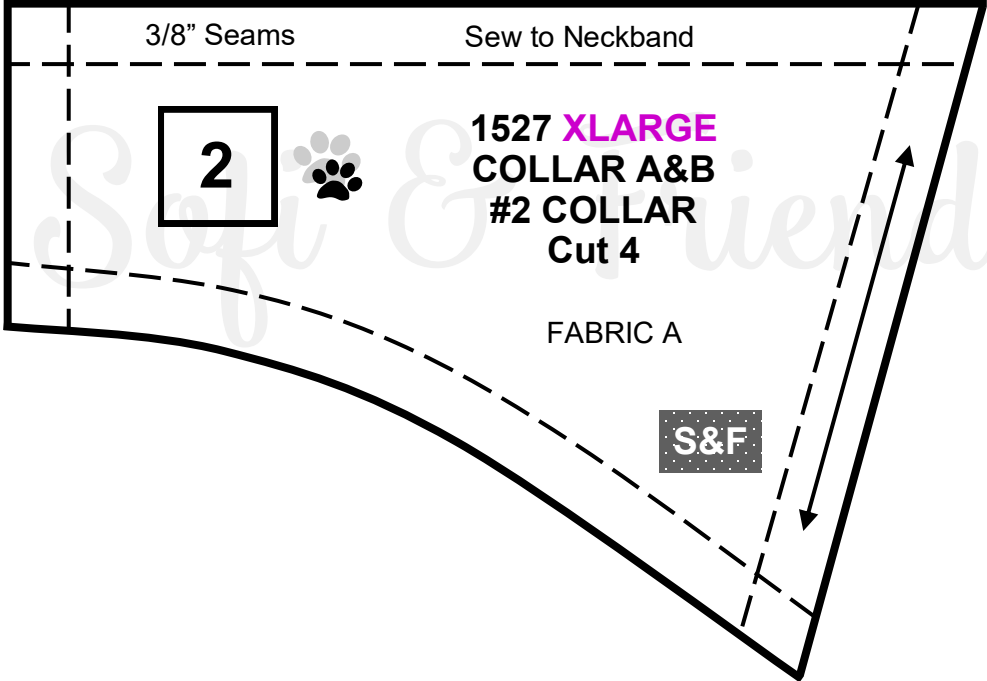
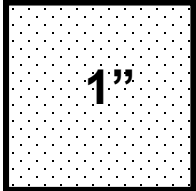

Sofi & Friends

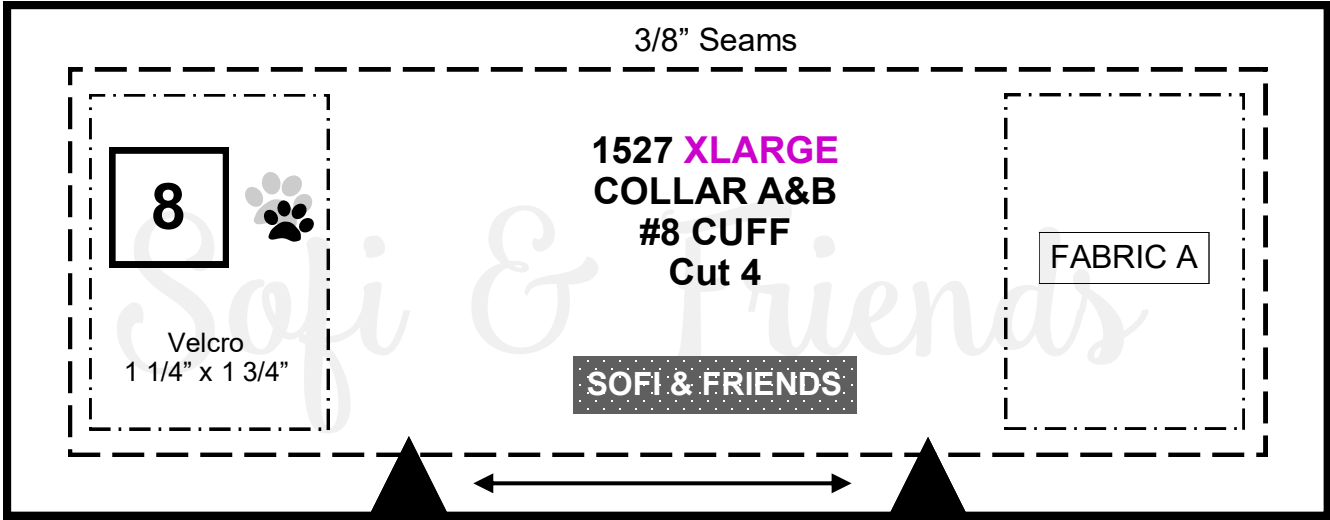

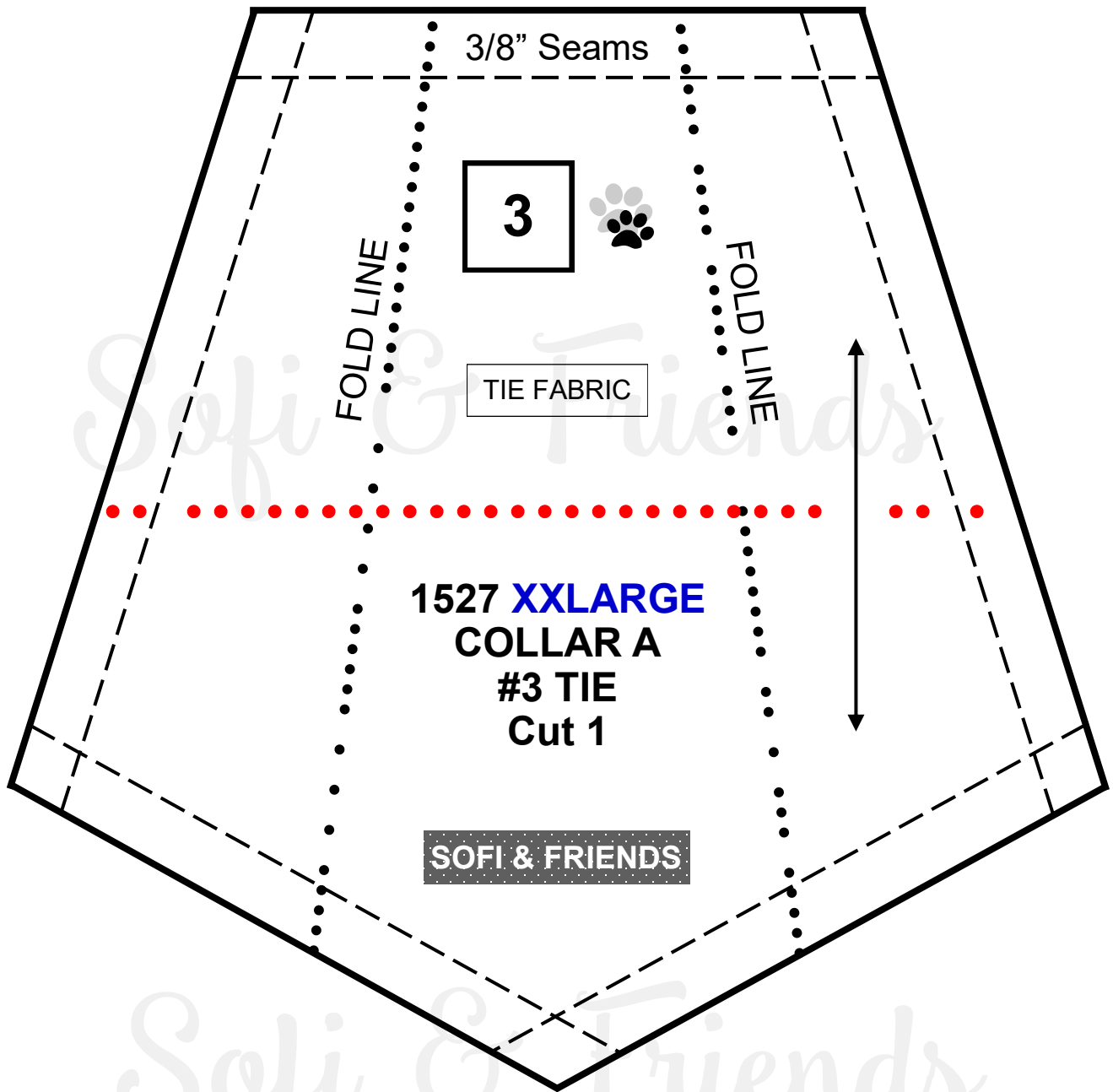
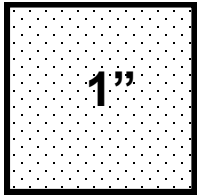
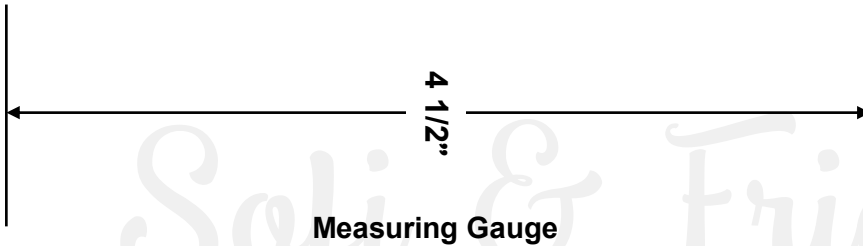



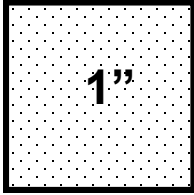
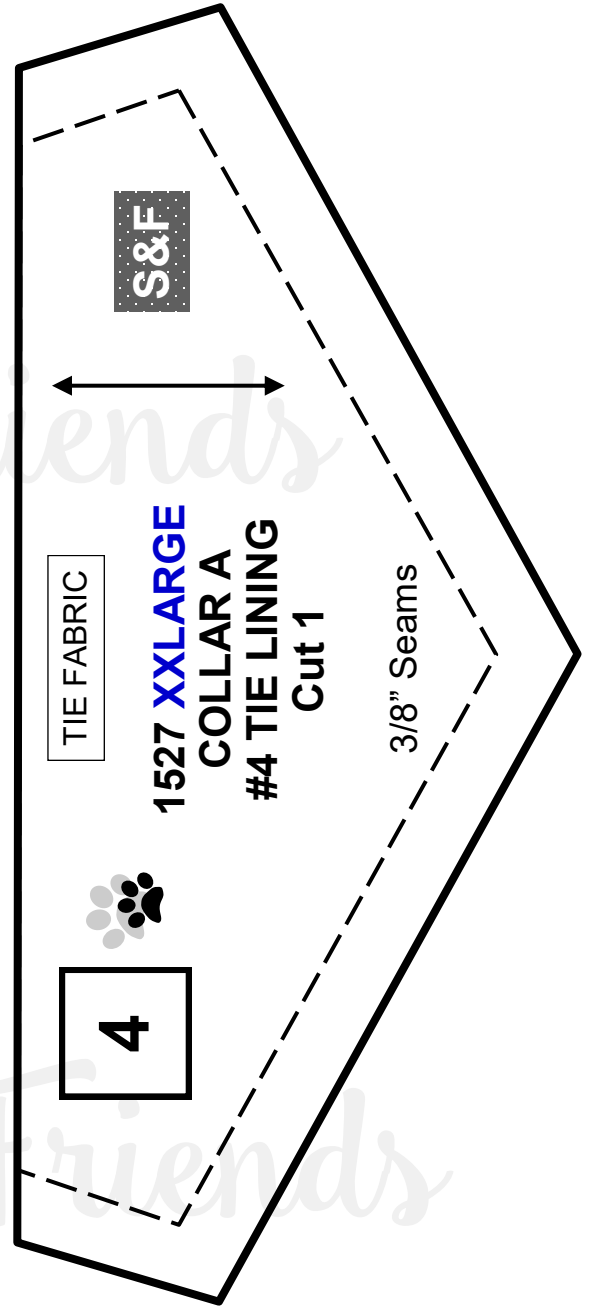
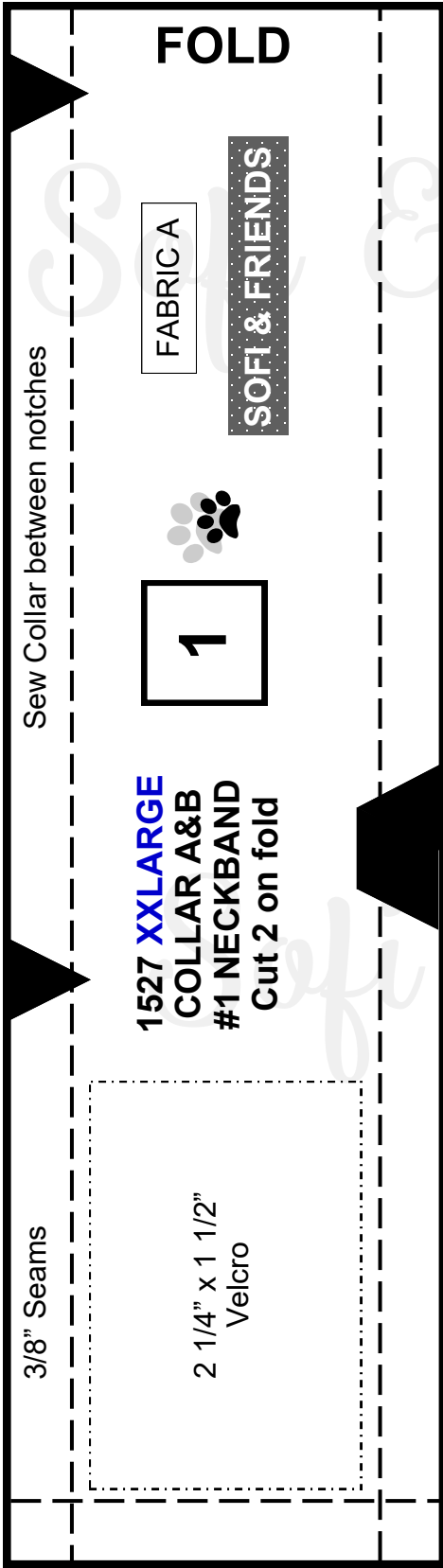

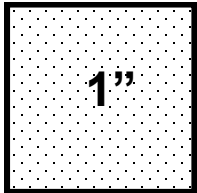
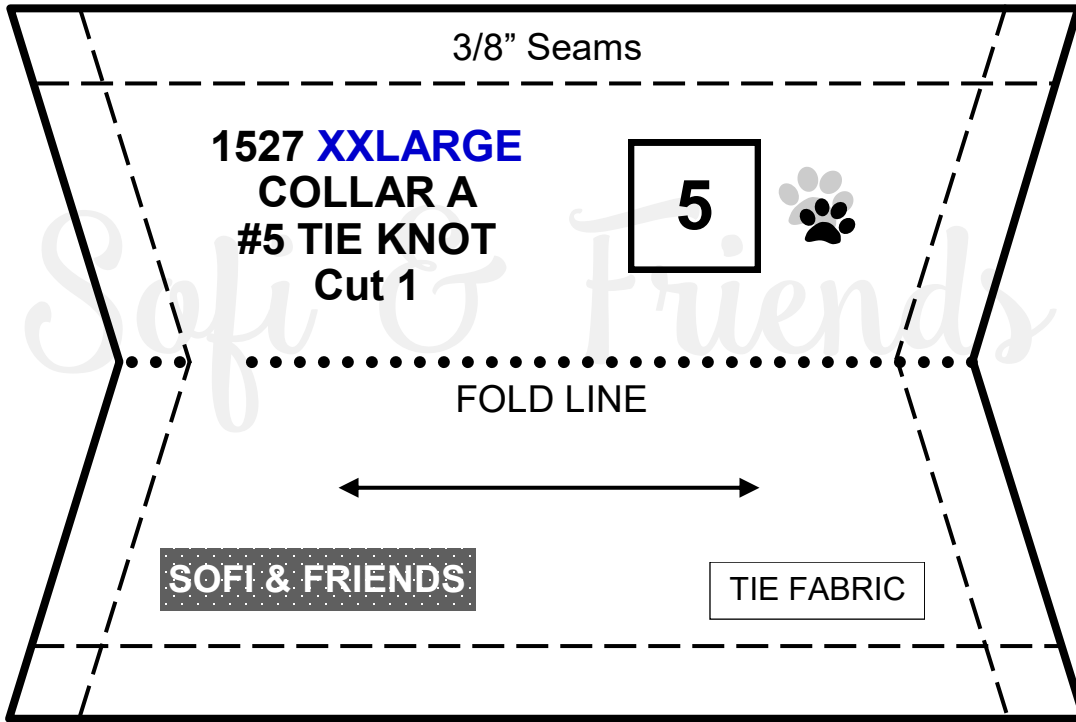

Sofi & Friends

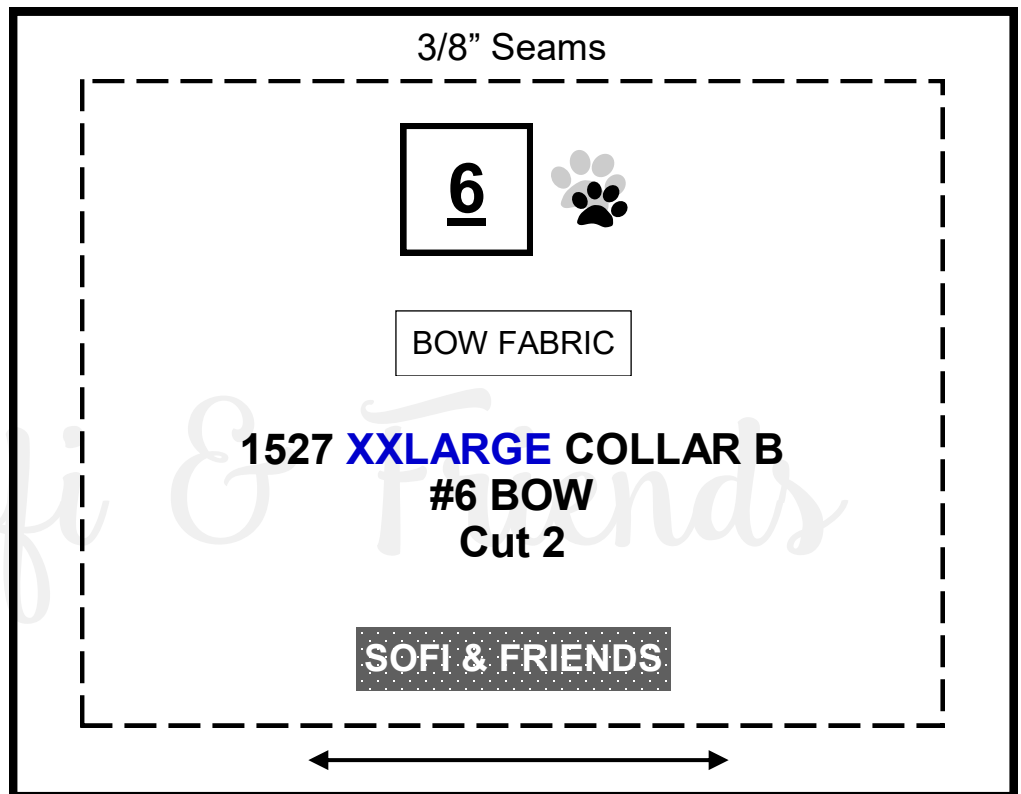

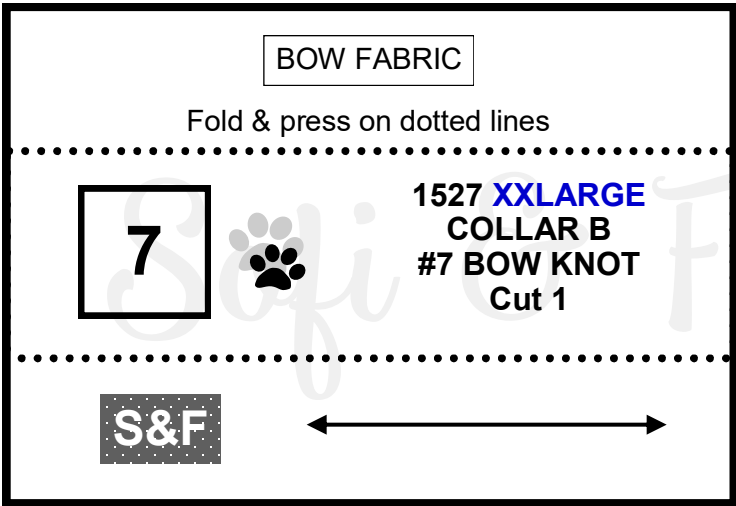
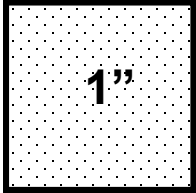

*Sofi & Friends*

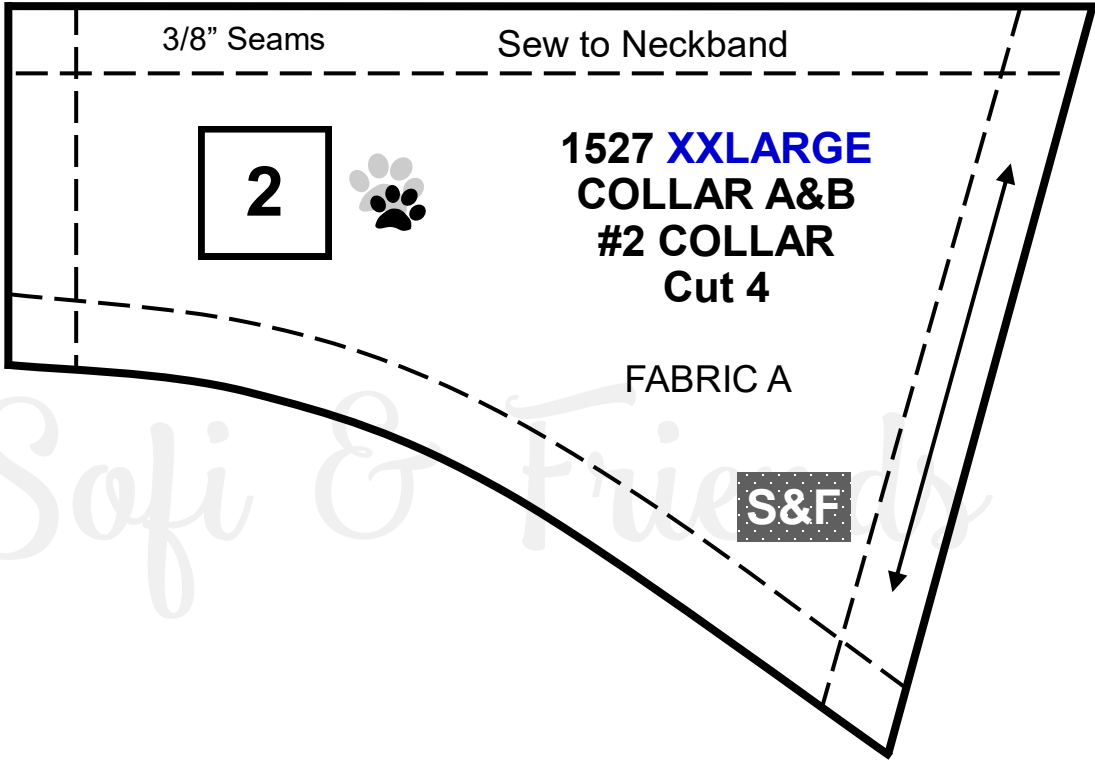

*Sofi & Friends*

